

Building Bulletin 93 aims to:

- provide a regulatory framework for the acoustic design of schools in support of the Building Regulations
- give supporting advice and recommendations for planning and design of schools
- provide a comprehensive guide for architects, acousticians, building control officers, building services engineers, clients, and others involved in the design of new school buildings.

The constructional standards for acoustics for new school buildings, as given in Section 1 of this document, are required to be achieved under the Building Regulations. This represents a significant tightening of the regulation of acoustic design in schools, to reflect a general recognition, supported by research, that teaching and learning are acoustically demanding activities. In particular, there is a consensus that low ambient noise levels are required, particularly in view of the requirements of the Special Educational Needs and Disability Act 2001¹ for integration of children with special needs in mainstream schools.

Unfortunately, a large number of classrooms in the UK currently suffer from poor acoustics. The most serious acoustic problems are due to noise transfer between rooms and/or excessive reverberation in rooms. There are many reasons for the poor acoustics, for example:

- The acoustics of the stock of old Victorian schools are often unsuitable for modern teaching methods.
- Modern constructions do not always provide adequate sound insulation and may need special treatment.
- Open plan, or semi-open plan layouts, designed to accommodate a number of different activities, are areas where background noise and sound intrusion often cause problems.
- The acoustics of multi-purpose rooms, such as halls, have to be suitable for a variety of activities, for example music (which requires a long reverberation time) and speech (which requires shorter reverberation times).

- Many activities, such as music and design technology lessons, can be noisy and will cause problems if there is inadequate sound insulation between areas for these activities and those requiring quieter conditions.

Poor acoustic conditions in the classroom increase the strain on teachers' voices as most teachers find it difficult to cope with high noise levels. This often leads to voice problems due to prolonged use of the voice and the need to shout to keep control. Recent surveys in the UK and elsewhere show that teachers form a disproportionate percentage of voice clinic patients.

Historically, there have been a number of factors preventing good acoustic design and this Building Bulletin addresses these issues.

- Before 2003, Part E of the Building Regulations did not apply to schools. It now includes schools within its scope.
- Although the constructional standards for schools previously quoted Building Bulletin 87^[2] as the standard for acoustics in schools, many designers were unaware of the requirements of BB87 and the standards were rarely enforced. These standards have been updated to reflect current research and the relevant requirements of the Disability Discrimination Act, and are included in the compliance section, Section 1, of this bulletin.
- The pressure on finances has meant in the past that acoustics came low on the list of design priorities. The acoustic design will now have a higher priority as it will be subject to building control

1. Now incorporated as Section IV of the Disability Discrimination Act^[1]

approval procedures.

- There has been little guidance available in the past on how to achieve the right balance of acoustics in the complex and dynamic environment of a school.

Architects and designers have had a difficult time finding information to make design easy and, in particular, to help them choose the correct target values of appropriate parameters.

Overall, Building Bulletin 93 recommends a structured approach to acoustic design at each stage of the planning and design process, as shown in the table below.

A structured approach to acoustic design at each stage of the planning and design process

Feasibility/Sketch Design	<ul style="list-style-type: none">■ Selection of the site■ Noise survey to establish external noise levels■ Orientation of buildings■ Massing and form of the buildings■ Consideration of need for external noise barriers using the buildings, fences and screens and landscape features■ Preliminary calculation of sound insulation provided by building envelope including the effect of ventilation openings
Detailed Design	<ul style="list-style-type: none">■ Determine appropriate noise levels and reverberation times for the various activities and room types■ Consider the special educational needs of the pupils■ Consider the design of music, drama and other specialist spaces separately from that of normal classrooms as the design criteria are very different.■ Provide the necessary façade sound insulation whilst providing adequate ventilation, particularly in the case of spaces such as classrooms and science laboratories which require high ventilation rates■ Architectural/acoustic zoning: plan the disposition of 'quiet' and 'noisy' spaces, separating them wherever possible by distance, external areas or neutral 'buffer' spaces such as storerooms or corridors■ Consider sound insulation separately from other aspects of room acoustics using walls, floors and partitions to provide adequate sound insulation■ Design the acoustics of the rooms by considering their volume and shape, and the acoustic properties of their surfaces■ Specify the acoustic performance of doors, windows and ventilation openings■ Specify any amplification systems
Building Control Approval	<ul style="list-style-type: none">■ Submit plans, including specific details of the acoustic design, for approval by Building Control Body

SCOPE of Building Bulletin 93

Section 1 of Building Bulletin 93 supersedes Section A of Building Bulletin 87^[2] as the constructional standard for acoustics for new school buildings.

In addition, Part E of the Building Regulations includes schools within its scope and Approved Document E^[3] gives the following guidance: *“In the Secretary of State’s view the normal way of satisfying Requirement E4 will be to meet the values for sound insulation, reverberation time and internal ambient noise which are given in Section 1 of Building Bulletin 93 ‘The Acoustic Design of Schools’, produced by DfES.”*

The requirements of Section 1 came into force on 1st July 2003, at the same time as those contained in the new Approved Document Part E^[3], in support of the Building Regulations.

Requirement E4 from Part E of Schedule 1 to The Building Regulations 2000 (as amended) states that:

“Each room or other space in a school building shall be designed and constructed in such a way that it has the acoustic conditions and the insulation against disturbance by noise appropriate to its intended use.”

The Education (School Premises) Regulations 1999, SI 1999 No.2 which applies to both new and existing school buildings, contains a similar statement: *“Each room or other space in a school building shall have the acoustic conditions and the insulation against disturbance by noise appropriate to its normal use.”*

Compliance with the acoustic performance standards specified in Section 1 will satisfy both regulations for new schools.

Although Building Regulations do not apply to all alteration and refurbishment work, it is desirable that such work should consider acoustics and incorporate upgrading of the acoustics as appropriate. (In the case of existing buildings, the Building Regulations apply only to ‘material alterations’ as defined in Regulations 3 and 4.) Although it would be uneconomic to upgrade all existing school buildings to the same standards as

new school buildings, where there is a need for upgrading the acoustic performance of an existing building or when refurbishment is happening for other reasons, then the designer should aim to meet the acoustic performance given in Section 1 of BB93 to satisfy the School Premises Regulations and the Disability Discrimination Act.

The exemption of Local Education Authority (LEA) maintained schools from the Building Regulations has ended. New school buildings, including extensions to existing school buildings and new schools formed by change of use of other buildings, are now included in the Building Regulations and may be subject to detailed design checks and on-site inspections by Building Control Bodies.

The Building Regulations and hence the requirements of BB93 only apply in England and Wales. They apply to both LEA maintained schools and independent schools.

Temporary buildings are exempt from the Building Regulations. Temporary buildings are defined in Schedule 2 to the Building Regulations as those which are not intended to remain in place for longer than 28 days. What are commonly called temporary buildings in schools are classed as prefabricated buildings and are normally subject to the same Building Regulations requirements as other types of building. Additional guidance is given in Clause 0.6 of Approved Document E^[3]. A building that is created by dismantling, transporting and re-erecting the sub-assemblies on the same premises, or is constructed from sub-assemblies obtained from other premises or from stock manufactured before 1st July 2003, would normally be considered to meet the requirements for schools if it satisfies the relevant provisions relating to acoustic standards set out in the 1997 edition of Building Bulletin 87^[2].

The extension of Part E of Schedule 1 to the Building Regulations 2000 (as amended by SI 2002/2871) to schools applies to teaching and learning spaces. Therefore the performance standards in

the tables in Section 1 are required for compliance with Part E for all teaching and learning spaces. Part E of the Building Regulations is not intended to cover the acoustic conditions in administration and ancillary spaces not used for teaching and learning except in as far as they affect conditions in neighbouring teaching and learning spaces. Therefore consideration needs to be given to adjoining areas, such as corridors, which might have doors, ventilators, or glazing separating them from a teaching or learning space. The performance standards given in the tables for administration and ancillary spaces are for guidance only.

Rooms used for nursery and adult/community education within school complexes are also covered by Part E. Part E does not apply to nursery schools which are not part of a school, sixth form colleges which have not been established as schools, and Universities or Colleges of Further and Higher Education². However, many of the acoustic specifications are desirable and can be used as a guide to the design of these buildings. The standards are particularly appropriate for nursery schools as figures are quoted for nursery spaces within primary schools.

The Disability Discrimination Act

1995^[1], as amended by the Special Educational Needs and Disability Act 2001, places a duty on all schools and LEAs to plan to increase over time the accessibility of schools for disabled pupils and to implement their plans. Schools and LEAs are required to provide:

- increased access for disabled pupils to the school curriculum. This covers teaching and learning and the wider curriculum of the school such as after-school clubs, leisure and cultural activities.
- improved access to the physical environment of schools, including physical aids to assist education. This includes acoustic improvements and aids for hearing impaired pupils.

When alterations affect the acoustics of a space then improvement of the acoustics to promote better access for children with special needs, including hearing impairments, should be considered.

Approved Document M: 1999 – Access and facilities for disabled people, in support of the Building Regulations^[4] includes requirements for access for children with special needs. See also BS 8300: 2001 Design of buildings and their approaches to meet the needs of disabled people^[5].

2. Part E of the Building Regulations quotes the definition of school given in Section 4 of the 1996 Education Act. In the case of sixth form colleges Section 4 of the 1996 Act should be read in conjunction with Section 2 of the same Act, in particular subsections (2), (2A) and (4) which deal with the definition of secondary education.

If a sixth form college is established as a school under the 1998 School Standards and Framework Act then it will be classed as a school under Section 4 of the 1996 Education Act and Part E of the Building Regulations on acoustics will apply. Only one sixth form college has been established in this way up until now.

Therefore, most sixth form colleges are institutions in the Further Education sector and not schools, and Part E of the Building Regulations will not apply.

In the case of a new sixth form college it will be necessary to contact the LEA to enquire if the sixth form college has been established as a school or as an Institute of Further Education.

Overview of contents of Building Bulletin 93

Section 1: Specification of Acoustic Performance consists of three parts.

Section 1.1 gives the performance standards for new school buildings to comply with the Building Regulations. These provide a good minimum standard for school design. However, on occasion higher standards will be necessary.

Section 1.2 sets out the preferred means of demonstrating compliance to the Building Control Body.

Section 1.3 gives the tests recommended to be conducted as part of the building contract.

Section 2: Noise Control describes how to conduct a site survey and to plan the school to control noise. It also includes recommendations on maximum external noise levels applying to playing fields, recreational areas and areas used for formal and informal outdoor teaching. External levels are not covered by Building Regulations but are taken into consideration in planning decisions by local authorities^[6].

Section 3: Sound Insulation gives detailed guidance on constructions to meet the performance standards for sound insulation specified in Section 1.1.

Section 4: The Design of Rooms for Speech and Section 5: The Design of Rooms for Music give guidance on various aspects of acoustic design relevant to schools.

Section 6: Acoustic Design and Equipment for Pupils with Special Hearing Requirements discusses design appropriate for pupils with hearing impairments and special hearing requirements. It discusses the necessary acoustic performance of spaces and describes the range of aids available to help these pupils.

Section 7 contains 10 case studies illustrating some of the most important aspects of acoustic design of schools.

Appendix 1 defines the basic concepts and technical terms used in the Bulletin.

Appendices 2 and 3 describe the basic principles of room acoustics and sound insulation.

Appendices 4 to 7 give examples of calculations of sound insulation, reverberation time and absorption.

Appendix 8 gives equipment specifications for sound field systems to guide those who need to specify this type of equipment.

Appendix 9 gives an overview of the Noise at Work Regulations as they relate to teachers.

Appendix 10 gives an example of a submission for approval by a Building Control Body.

The DfES acoustics website www.teachernet.gov.uk/acoustics contains further reference material which expands on the source material for acousticians and designers. For example, it links to a spreadsheet which can be used to calculate the sound insulation of the building envelope and the reverberation time of internal rooms. The website will be regularly updated with new information, discussion papers and case studies. The website also contains complete downloads of BB93.

References

- [1] Disability Discrimination Act (1995) Part IV
www.hmso.gov.uk
- [2] Building Bulletin 87, Guidelines for Environmental Design in Schools (Revision of Design Note 17), The Stationery Office, 1997. ISBN 011 271013 1. (Now superseded by 2003 version of BB87, which excludes acoustics, and is available on www.teachernet.gov.uk/energy)
- [3] Approved Document E – Resistance to the passage of sound. Stationery Office, 2003. ISBN 0 11 753 642 3. www.odpm.gov.uk
- [4] Approved Document M:1999 Access and facilities for disabled people, in support of the Building Regulations, Stationery Office, 1999 ISBN 0 11 753469. To be replaced shortly by Approved Document M, Access to and use of buildings. www.odpm.gov.uk
- [5] BS 8300: 2001 Design of buildings and their approaches to meet the needs of disabled people, Code of Practice.
- [6] PPG 24, Planning Policy Guidance: Planning and Noise, Department of the Environment, The Stationery Office, September 1994. To be replaced by revised Planning Policy documents.

Specification of acoustic performance

1

SECTION

Section 1 of Building Bulletin 93 sets the performance standards for the acoustics of new buildings, and describes the normal means of demonstrating compliance with The Building Regulations.

Contents

1.1 Performance standards	9
1.1.1 Indoor ambient noise levels in unoccupied spaces	9
1.1.2 Airborne sound insulation between spaces	12
1.1.3 Airborne sound insulation between circulation spaces and other spaces used by students	12
1.1.4 Impact sound insulation of floors	13
1.1.5 Reverberation in teaching and study spaces	14
1.1.6 Sound absorption in corridors, entrance halls and stairwells	15
1.1.7 Speech intelligibility in open-plan spaces	16
1.2 Demonstrating compliance to the Building Control Body	17
1.2.1 Alternative performance standards	17
1.3 Demonstrating compliance to the client	18
1.3.1 Timetabling of acoustic testing	18
1.3.2 Remedial treatments	18
1.3.3 Indoor ambient noise levels in unoccupied spaces	18
1.3.4 Airborne sound insulation between spaces	18
1.3.5 Airborne sound insulation between circulation spaces and other spaces used by students	18
1.3.6 Impact sound insulation	18
1.3.7 Reverberation in teaching and study spaces	18
1.3.8 Sound absorption in corridors, entrance halls and stairwells	19
1.3.9 Speech intelligibility in open-plan spaces	19
References	19

The normal way of satisfying Requirement E4 of The Building Regulations is to demonstrate that all the performance standards in Section 1.1, as appropriate, have been met.

Section 1.2 sets out the preferred means for demonstrating compliance of the design to the Building Control Body.

Section 1.3 describes acoustic tests that can be used to demonstrate compliance with the performance standards in Section 1.1. It is strongly recommended that the client require acoustic testing to be carried out as part of the building contract, because testing of the completed

construction is the best practical means of ensuring that it achieves the design intent.

In all but the simplest of projects it is advisable to appoint a suitably qualified acoustic consultant¹ at an early stage of the project, before the outline design has been decided. This will prevent simple mistakes which can be costly to design out at a later stage. An acoustic consultant will normally be needed to check the design details and on-site construction, and to carry out acoustic tests to confirm that the building achieves the required acoustic performance.

1 The primary professional body for acoustics in the UK is the Institute of Acoustics. An experienced professional acoustician who is competent to be responsible for the acoustic design of school buildings would normally be a corporate member of the Institute of Acoustics.

1.1 Performance standards

The overall objective of the performance standards in Section 1.1 is to provide acoustic conditions in schools that (a) facilitate clear communication of speech between teacher and student, and between students, and (b) do not interfere with study activities.

Performance standards on the following topics are specified in this section to achieve this objective:

- indoor ambient noise levels
- airborne sound insulation between spaces
- airborne sound insulation between corridors or stairwells and other spaces
- impact sound insulation of floors
- reverberation in teaching and study spaces
- sound absorption in corridors, entrance halls and stairwells
- speech intelligibility in open-plan spaces.

All spaces should meet the performance standards defined in Tables 1.1, 1.2, 1.3, 1.4 and 1.5 for indoor ambient noise level, airborne and impact sound insulation, and reverberation time. Open-plan spaces should additionally meet the performance standard for speech intelligibility in Table 1.6.

The notes accompanying Tables 1.1, 1.2, 1.3 and 1.5 contain additional guidance that should be considered when designing the spaces to meet the performance standards in these tables. Although good practice, this guidance will not be enforced under the Building Regulations.

1.1.1. Indoor ambient noise levels in unoccupied spaces

The objective is to provide suitable indoor ambient noise levels (a) for clear communication of speech between teacher and student, and between students and (b) for study activities.

The indoor ambient noise level includes noise contributions from:

- external sources outside the school premises (including, but not limited to, noise from road, rail and air traffic, industrial and commercial premises)
- building services (eg ventilation system,

plant, etc). If a room is naturally ventilated, the ventilators or windows should be assumed to be open as required to provide adequate ventilation. If a room is mechanically ventilated, the plant should be assumed to be running at its maximum operating duty.

The indoor ambient noise level excludes noise contributions from:

- teaching activities within the school premises, including noise from staff, students and equipment within the building or in the playground. Noise transmitted from adjacent spaces is addressed by the airborne and impact sound insulation requirements.
- equipment used in the space (eg machine tools, CNC machines, dust and fume extract equipment, compressors, computers, overhead projectors, fume cupboards). However, these noise sources should be considered in the design process.
- rain noise. However, it is essential that

NOTES ON TABLE 1.1

1 Research indicates that teaching can be disrupted by individual noisy events such as aircraft flyovers, even where the noise level is below the limits in Table 1.1. For rooms identified in Table 1.1 having limits of 35 dB or less the noise level should not regularly exceed 55 dB $L_{A1,30min}$.

2 Acoustic considerations of open-plan areas are complex and are discussed in Section 1.1.7 and Section 4.

3 Studios require specialised acoustic environments and the noise limits for these will vary with the size, intended use and type of room. In some cases noise limits below 30 dB L_{Aeq} may be required, and separate limits for different types of noise may be appropriate; specialist advice should be sought.

4 Halls are often multi-functional spaces (especially in primary schools) used for activities such as dining, PE, drama, music, assembly, and performing plays and concerts. In such multi-functional spaces the designer should design to the lowest indoor ambient noise level for which the space is likely to be used. For large halls used for formal drama and music performance lower noise levels than those in Table 1.1 are preferable, and levels of 25 dB $L_{Aeq,30min}$ may be appropriate. In these cases specialist advice should be sought.

Type of room	Room classification for the purpose of airborne sound insulation in Table 1.2		Upper limit for the indoor ambient noise level $L_{Aeq,30min}$ (dB)
	Activity noise (Source room)	Noise tolerance (Receiving room)	
Nursery school playrooms	High	Low	35 ¹
Nursery school quiet rooms	Low	Low	35 ¹
Primary school: classrooms, class bases, general teaching areas, small group rooms	Average	Low	35 ¹
Secondary school: classrooms, general teaching areas, seminar rooms, tutorial rooms, language laboratories	Average	Low	35 ¹
<i>Open-plan</i> ²			
Teaching areas	Average	Medium	40 ¹
Resource areas	Average	Medium	40 ¹
<i>Music</i>			
Music classroom	Very high	Low	35 ¹
Small practice/group room	Very high	Low	35 ¹
Ensemble room	Very high	Very low	30 ¹
Performance/recital room	Very high	Very low	30 ¹
Recording studio ³	Very high	Very low	30 ¹
Control room for recording	High	Low	35 ¹
<i>Lecture rooms</i>			
Small (fewer than 50 people)	Average	Low	35 ¹
Large (more than 50 people)	Average	Very low	30 ¹
Classrooms designed specifically for use by hearing impaired students (including speech therapy rooms)	Average	Very low	30 ¹
Study room (individual study, withdrawal, remedial work, teacher preparation)	Low	Low	35 ¹
<i>Libraries</i>			
Quiet study areas	Low	Low	35 ¹
Resource areas	Average	Medium	40
Science laboratories	Average	Medium	40
Drama studios	High	Very low	30 ¹
Design and Technology			
• Resistant materials, CAD/CAM areas	High	High	40
• Electronics/control, textiles, food, graphics, design/resource areas	Average	Medium	40
Art rooms	Average	Medium	40
Assembly halls ⁴ , multi-purpose halls ⁴ (drama, PE, audio/visual presentations, assembly, occasional music)	High	Low	35 ¹
Audio-visual, video conference rooms	Average	Low	35 ¹
Atria, circulation spaces used by students	Average	Medium	45
Indoor sports hall	High	Medium	40
Dance studio	High	Medium	40
Gymnasium	High	Medium	40
Swimming pool	High	High	50
Interviewing/counselling rooms, medical rooms	Low	Low	35 ¹
Dining rooms	High	High	45
<i>Ancillary spaces</i>			
Kitchens*	High	High	50
Offices*, staff rooms*	Average	Medium	40
Corridors*, stairwells*	Average - High	High	45
Coats and changing areas*	High	High	45
Toilets*	Average	High	50

* Part E of Schedule 1 to the Building Regulations 2000 (as amended by SI 2002/2871) applies to teaching and learning spaces and is not intended to cover administration and ancillary spaces (see under Scope in the Introduction). For these areas the performance standards are for guidance only.

Table 1.1: Performance standards for indoor ambient noise levels - upper limits for the indoor ambient noise level, $L_{Aeq,30min}$

Table 1.2: Performance standards for airborne sound insulation between spaces - minimum weighted BB93 standardized level difference, $D_{nT}(T_{mf,max}),w$

Minimum $D_{nT}(T_{mf,max}),w$ (dB)		Activity noise in source room (see Table 1.1)			
		Low	Average	High	Very high
Noise tolerance in receiving room (see Table 1.1)	High	30	35	45	55
	Medium	35	40	50	55
	Low	40	45	55	55
	Very low	45	50	55	60

NOTES ON TABLE 1.2

1 Each value in the table is the minimum required to comply with the Building Regulations. A value of 55 dB $D_{nT}(T_{mf,max}),w$ between two music practice rooms will not mean that the music will be inaudible between the rooms; in many cases, particularly if brass or percussion instruments are played, a higher value is desirable.

2 Where values greater than 55 dB $D_{nT}(T_{mf,max}),w$ are required it is advisable to separate the rooms using acoustically less sensitive areas such as corridors and storerooms. Where this is not possible, high performance constructions are likely to be required and specialist advice should be sought.

3 It is recommended that music rooms should not be placed adjacent to design and technology spaces or art rooms.

4 These values of $D_{nT}(T_{mf,max}),w$ include the effect of glazing, doors and other weaknesses in the partition. In general, normal (non-acoustic) doors provide much less sound insulation than the surrounding walls and reduce the overall $D_{nT}(T_{mf,max}),w$ of the wall considerably, particularly for values above 35 dB $D_{nT}(T_{mf,max}),w$. Therefore, doors should not generally be installed in partitions between rooms requiring values above 35 dB $D_{nT}(T_{mf,max}),w$ unless acoustic doors, door lobbies, or double doors with an airspace are used. This is not normally a problem as rooms are usually accessed via corridors or circulation spaces so that there are at least two doors between noise-sensitive rooms. For more guidance see Section 3.

this noise is considered in the design of lightweight roofs and roof lights as it can significantly increase the indoor ambient noise level (see the design guidance in Section 3.1.1). It is intended that a performance standard for rain noise will be introduced in a future edition of BB93. To satisfy this edition of BB93 it should be demonstrated to the Building Control Body that the roof has been designed to minimise rain noise (see Section 1.2).

Table 1.1 contains the required upper limits for the indoor ambient noise levels for each type of unoccupied space. The noise levels in Table 1.1 are specified in terms of $L_{Aeq,30min}$. This is an average noise level over 30 minutes, as explained in Appendix 1. The specified levels refer to the highest equivalent continuous A-weighted sound pressure level,

$L_{Aeq,30min}$, likely to occur during normal teaching hours. The levels due to external sources will depend on weather conditions (eg wind direction) and local activities. High noise levels due to exceptional events may be disregarded.

The indoor ambient noise levels in Table 1.1 apply to finished but unoccupied and unfurnished spaces.

Tonal and intermittent noises are generally more disruptive than other types of noise at the same level. Noise from plant, machinery and equipment in noise-sensitive rooms should therefore be constant in nature and should not contain any significant tonal or intermittent characteristics. Noise from building services which is discontinuous, tonal, or impulsive (ie noise which can be distracting) should be reduced to a level at least 5 dB below the specified maximum.

In rooms with very low noise tolerance, including music rooms, studios and rooms used for formal music and drama performance, any audible intermittent noise source of this type is likely to cause problems and specialist advice should be sought.

1.1.2. Airborne sound insulation between spaces

The objective is to attenuate airborne sound transmitted between spaces through walls and floors.

Table 1.2 contains the required minimum airborne sound insulation values between rooms. These values are defined by the activity noise in the source room and the noise tolerance in the receiving room. The activity noise and noise tolerance for each type of room are given in Table 1.1. The airborne sound insulation is quoted in terms of the weighted BB93 standardized level difference, $D_{nT}(T_{mf,max})_w$, between two rooms.

The BB93 standardized level difference, $D_{nT}(T_{mf,max})$, is the level difference, in decibels, corresponding to a BB93 reference value of the reverberation time in the receiving room:

$$D_{nT}(T_{mf,max}) = D + 10 \lg \frac{T}{T_{mf,max}} \text{ dB}$$

where

D is the level difference (dB)

T is the reverberation time in the receiving room (s)

$T_{mf,max}$ is the reference reverberation time equal to the upper limit of the reverberation time, T_{mf} , given in Table 1.5 for the type of receiving room. This reference reverberation time shall be used for all frequency bands.

The BB93 standardized level difference, $D_{nT}(T_{mf,max})_w$, is measured in accordance with BS EN ISO 140-4:1998^[1] in octave or one-third octave bands, the results are weighted and expressed as a single-number quantity, $D_{nT}(T_{mf,max})_w$, in accordance with BS EN ISO 717-1:1997^[2].

The prediction and measurement of $D_{nT}(T_{mf,max})_w$ between two rooms must be carried out in both directions as its value depends upon the volume of the receiving room, see the example below.

1.1.3 Airborne sound insulation between circulation spaces and other spaces used by students

The objective is to attenuate airborne sound transmitted between circulation spaces (eg corridors, stairwells) and other spaces used by students.

Table 1.3 contains the required minimum airborne sound insulation for the separating wall construction, any doorset in the wall and any ventilators in the wall. The airborne sound insulation for walls and doorsets is quoted in terms

Example to determine the performance standards for airborne sound insulation between a music classroom and a secondary school general teaching area.

From the music classroom (source room) to the general teaching area (receiving room):

Table 1.1 shows that music classrooms have 'very high' activity levels and that general teaching areas have 'low' tolerance. Table 1.2 shows that at least 55 dB $D_{nT}(0.8s)_w$ is required.

From the general teaching area (source room) to the music classroom (receiving room):

Table 1.1 shows that general teaching areas have 'average' activity levels and that music classrooms have 'low' tolerance. Table 1.2 shows that at least 45 dB $D_{nT}(1.0s)_w$ is required.

In this example the requirement to control noise from the music classroom to the general teaching area is more stringent.

The construction should be designed to achieve at least 55 dB $D_{nT}(0.8s)_w$ from the music classroom (source room) to the general teaching area (receiving room), and at least 45 dB $D_{nT}(1.0s)_w$ from the general teaching area (source room) to the music classroom (receiving room).

Table 1.3: Performance standards for airborne sound insulation between circulation spaces and other spaces used by students - minimum sound reduction index, R_w and minimum $D_{n,e,w} - 10\lg N$ (laboratory measurements)

Type of space used by students	Minimum R_w (dB)		Minimum $D_{n,e,w} - 10\lg N$ (dB)
	Wall including any glazing	Doorset ¹	
All spaces except music rooms	40	30	39
Music rooms ²	45	35	45 ³

NOTES ON TABLE 1.3

1 The R_w ratings are for the doorset alone. Manufacturers sometimes provide doorset sound insulation data as a combined rating for the wall and doorset where the R_w refers to the performance of an $\approx 10 \text{ m}^2$ high-performance wall containing the doorset. This is not appropriate as it gives higher figures than the R_w of the doorset itself. However, with knowledge of the wall and doorset areas the R_w of the doorset can be calculated from these test results.

2 Special design advice is recommended.

3 Wherever possible, ventilators should not be installed between music rooms and circulation spaces.

of the weighted sound reduction index, R_w , which is measured in the laboratory. The airborne sound insulation for ventilators is quoted in terms of the weighted element-normalized level difference, $D_{n,e,w}$. The performance standard for ventilators is quoted in terms of $D_{n,e,w} - 10\lg N$ where N is the number of ventilators with airborne sound insulation $D_{n,e,w}$.

The weighted sound reduction index is measured in accordance with BS EN ISO 140-3:1995^[3] and rated in accordance with BS EN ISO 717-1:1997^[2].

The weighted element-normalized level difference is measured in accordance with BS EN 20140-10:1992^[4] and rated in accordance with BS EN ISO 717-1:1997^[2].

Table 1.3 excludes:

- service corridors adjacent to spaces that are not used by students
- lobby corridors leading only to spaces used by students that have a high tolerance to noise as defined in Table 1.1.

The performance standard is set using

a laboratory measurement because of the difficulty in accurately measuring the airborne sound insulation between rooms and corridors, or rooms and stairwells in the field. Therefore it is crucial that the airborne sound insulation of the wall and/or doorset is not compromised by flanking sound transmission, eg sound transmission across the junction between the ceiling and the corridor wall (see guidance in Section 3.10.3).

1.1.4. Impact sound insulation of floors

The objective is to attenuate impact sound (eg footsteps) transmitted into spaces via the floor.

Table 1.4 contains the recommended maximum weighted BB93 standardized impact sound pressure level, $L'_{nT}(T_{mf,max})_w$, for receiving rooms of different types and uses.

The BB93 standardized impact sound pressure level, $L'_{nT}(T_{mf,max})$, is the impact sound pressure level in decibels corresponding to a BB93 reference value of the reverberation time in the receiving room:

$$L'_{nT}(T_{mf,max}) = L_i - 10 \lg \frac{T}{T_{mf,max}} \text{ dB}$$

where

L_i is the impact sound pressure level (dB)

T is the reverberation time in the receiving room (s)

$T_{mf,max}$ is the reference reverberation time equal to the upper limit of the reverberation time, T_{mf} , given in Table 1.5 for the type of receiving room. This reference reverberation time shall be used for all frequency bands.

The BB93 standardized impact sound pressure level, $L'_{nT}(T_{mf,max})$, is measured

in accordance with BS EN ISO 140-7:1998^[5] in octave or one-third octave bands, the results are weighted and expressed as a single-number quantity, $L'_{nT}(T_{mf,max})_w$, in accordance with BS EN ISO 717-2:1997^[6].

Impact sound insulation should be designed and measured for floors without a soft covering (eg carpet, foam backed vinyl) except in the case of concrete structural floor bases where the soft covering is an integral part of the floor.

1.1.5. Reverberation in teaching and study spaces

The objective is to provide suitable reverberation times for (a) clear communication of speech between teacher and student, and between students, in teaching and study spaces and (b) music teaching and performance.

Table 1.5 contains the required mid-frequency reverberation times for rooms which are finished but unoccupied and unfurnished. The reverberation time is quoted in terms of the mid-frequency reverberation time, T_{mf} , the arithmetic average of the reverberation times in the 500 Hz, 1 kHz and 2 kHz octave bands.

Sound absorption from pinboards and noticeboards can change when they are covered up or painted. Absorption coefficients for pinboards and noticeboards used in design calculations should be for fully covered or painted boards, as appropriate. If these data are not available then the absorption coefficient for the board area used in the design calculation should be the absorption coefficient of the wall to which the board is attached.

Table 1.4: Performance standards for impact sound insulation of floors - maximum weighted BB93 standardized impact sound pressure level $L'_{nT}(T_{mf,max})_w$

Type of room (receiving room)	Maximum weighted BB93 standardized impact sound pressure level $L'_{nT}(T_{mf,max})_w$ (dB)
Nursery school playrooms	65
Nursery school quiet rooms	60
Primary school: classrooms, class bases, general teaching areas, small group rooms	60
Secondary school: classrooms, general teaching areas, seminar rooms, tutorial rooms, language laboratories	60
<i>Open-plan</i>	
Teaching areas	60
Resource areas	60
<i>Music</i>	
Music classroom	55
Small practice/group room	55
Ensemble room	55
Performance/recital room	55
Recording studio	55
Control room for recording	55
<i>Lecture rooms</i>	
Small (fewer than 50 people)	60
Large (more than 50 people)	55
Classrooms designed specifically for use by hearing impaired students (including speech therapy rooms)	55
Study room (individual study, withdrawal, remedial work, teacher preparation)	60
Libraries	60
Science laboratories	65
Drama studios	55
Design and Technology	
• Resistant materials, CAD/CAM areas	65
• Electronics/control, textiles, food, graphics, design/resource areas	60
Art rooms	60
Assembly halls, multi-purpose halls (drama, PE, audio/visual presentations, assembly, occasional music)	60
Audio-visual, video conference rooms	60
Atria, circulation spaces used by students	65
Indoor sports hall	65
Gymnasium	65
Dance studio	60
Swimming pool	65
Interviewing/counselling rooms, medical rooms	60
Dining rooms	65
<i>Ancillary spaces</i>	
Kitchens*	65
Offices*, staff rooms*	65
Corridors*, stairwells*	65
Coats and changing areas*	65
Toilets*	65

* Part E of Schedule 1 to the Building Regulations 2000 (as amended by SI 2002/2871) applies to teaching and learning spaces and is not intended to cover administration and ancillary spaces (see under Scope in the Introduction). For these areas the performance standards are for guidance only.

Type of room	T_{mf} ¹ (seconds)
Nursery school playrooms	<0.6
Nursery school quiet rooms	<0.6
Primary school: classrooms, class bases, general teaching areas, small group rooms	<0.6
Secondary school: classrooms, general teaching areas, seminar rooms, tutorial rooms, language laboratories	<0.8
<i>Open-plan</i>	
Teaching areas	<0.8
Resource areas	<1.0
<i>Music</i>	
Music classroom	<1.0
Small practice/group room	<0.8
Ensemble room	0.6 - 1.2
Performance/recital room ³	1.0 - 1.5
Recording studio	0.6 - 1.2
Control room for recording	<0.5
<i>Lecture rooms³</i>	
Small (fewer than 50 people)	<0.8
Large (more than 50 people)	<1.0
Classrooms designed specifically for use by hearing impaired students (including speech therapy rooms)	<0.4
Study room (individual study, withdrawal, remedial work, teacher preparation)	<0.8
Libraries	<1.0
Science laboratories	<0.8
Drama studios	<1.0
Design and Technology	
• Resistant materials, CAD/CAM areas	<0.8
• Electronics/control, textiles, food, graphics, design/resource areas	<0.8
Art rooms	<0.8
Assembly halls, multi-purpose halls (drama, PE, audio/visual presentations, assembly, occasional music) ^{2,3}	0.8 - 1.2
Audio-visual, video conference rooms	<0.8
Atria, circulation spaces used by students	<1.5
Indoor sports hall	<1.5
Gymnasium	<1.5
Dance studio	<1.2
Swimming pool	<2.0
Interviewing/counselling rooms, medical rooms	<0.8
Dining rooms	<1.0
<i>Ancillary spaces</i>	
Kitchens*	<1.5
Offices*, staff rooms*	<1.0
Corridors, stairwells	See Section 1.1.6
Coats and changing areas*	<1.5
Toilets*	<1.5

Table 1.5: Performance standards for reverberation in teaching and study spaces – mid-frequency reverberation time, T_{mf} , in finished but unoccupied and unfurnished rooms

* Part E of Schedule 1 to the Building Regulations 2000 (as amended by SI 2002/2871) applies to teaching and learning spaces and is not intended to cover administration and ancillary spaces (see under Scope in the Introduction). For these areas the performance standards are for guidance only.

1.1.6. Sound absorption in corridors, entrance halls and stairwells

The objective is to absorb sound in corridors, entrance halls and stairwells so that it does not interfere with teaching and study activities in adjacent rooms.

The requirement is to provide additional sound absorption in corridors, entrance halls and stairwells. The amount of additional absorption should be calculated according to Approved Document E^[7], Section 7. This describes two calculation methods, A and B, for controlling reverberation in the common internal parts of domestic buildings. One of these methods should be used to determine the amount of absorption required in corridors, entrance halls and stairwells in schools. (See sample calculations using calculation methods A and B in Appendix 7.)

Sound absorption from pinboards and noticeboards can change when they are covered up or painted. Absorption coefficients for pinboards and noticeboards used in design calculations should be for fully covered or painted boards, as appropriate. If these data are not available then the absorption

NOTES ON TABLE 1.5

1 Common materials often absorb most sound at high frequencies. Therefore reverberation times will tend to be longer at low frequencies than at high frequencies. In rooms used primarily for speech, the reverberation times in the 125 Hz and 250 Hz octave bands may gradually increase with decreasing frequency to values not more than 30% above T_{mf} .

2 For very large halls and auditoria, and for halls designed primarily for unamplified music rather than speech, designing solely in terms of reverberation time may not be appropriate and specialist advice should be sought. In large rooms used primarily for music, it may be appropriate for the reverberation times in the 125 Hz and 250 Hz octave bands to gradually increase with decreasing frequency to values up to 50% above T_{mf} . For more guidance see Section 5.

3 Assembly halls, multi-purpose halls, lecture rooms and music performance/recital rooms may be considered as unfurnished when they contain permanent fixed seating. Where retractable (bleacher) seating is fitted, the performance standards apply to the space with the seating retracted.

coefficient for the board area used in the design calculation should be the absorption coefficient of the wall to which the board is attached.

1.1.7 Speech intelligibility in open-plan spaces

The objective is to provide clear communication of speech between teacher and student, and between students, in open-plan teaching and study spaces.

For enclosed teaching and study spaces it is possible to achieve good speech intelligibility through specification of the indoor ambient noise level, sound insulation and reverberation time. Open-plan spaces require extra specification as they are significantly more complex acoustic spaces. The main issue is that the noise from different groups of people functioning independently in the space significantly increases the background noise level, thus decreasing speech intelligibility.

Open-plan spaces are generally designed for high flexibility in terms of the layout of teaching and study spaces. In addition, the layout is rarely finalised before the school is operational. This increases the complexity of assessing speech intelligibility in the open-plan space. Therefore, at an early stage in the design, the designer should establish the expected open-plan layout and activity plan with the client.

The open-plan layout should include:

- the positions at which the teacher will give oral presentations to groups of students
- the seating plan for the students and teachers in each learning base
- the learning base areas.

The activity plan should include:

- the number of teachers giving oral presentations to groups of students at any one time
- the number of students engaged in discussion at any one time
- the number of people walking through the open-plan space (eg along corridors and walkways) during teaching and study periods
- any machinery (eg engraving machines, CNC machines, dust and fume extract

Room type	Speech Transmission Index (STI)
Open-plan teaching and study spaces	>0.60

equipment, computers, printers, AVA) operating in the open-plan space.

The expected open-plan layout and activity plan should be agreed as the basis on which compliance with BB93 can be demonstrated to the Building Control Body.

The activity plan should be used to establish the overall noise level due to the combination of the indoor ambient noise level, all activities in the open-plan space (including teaching and study), and transmitted noise from adjacent spaces. A computer prediction model should be used to calculate the Speech Transmission Index (STI)^[8] in the open-plan space, using the overall noise level as the background noise level. Other methods of estimating STI may also be applicable.

The performance standard for speech intelligibility in open-plan spaces is described in terms of the Speech Transmission Index in Table 1.6. The calculated value of STI should be between 0.60 and 1.00, which gives an STI rating of either ‘good’ or ‘excellent’. This performance standard applies to speech transmitted from teacher to student, student to teacher and student to student.

The performance standard in Table 1.6 is intended to ensure that open-plan spaces in schools are only built when suited to the activity plan and layout. With some activity plans, room layouts and open-plan designs it will not be possible to achieve this performance standard. At this point in the design process the decision to introduce an open-plan space into the school should be thoroughly re-assessed. If, after re-assessment, there is still a need for the open-plan space, then the inclusion of operable walls between learning bases should be considered. These operable walls will form classrooms and be subject to the airborne sound insulation requirements in Table 1.2. It is not appropriate to simply adjust the activity

Table 1.6: Performance standard for speech intelligibility in open-plan spaces – Speech Transmission Index (STI)

plan until the performance standard for speech intelligibility is met.

Computer prediction software capable of simulating an impulse response should be used to create a three-dimensional geometric model of the space, comprising surfaces with scattering coefficients and individually assigned absorption coefficients for each frequency band. The model should allow for the location and orientation of single and multiple sources with user-defined sound power levels and directivity. (See guidance on computer prediction models on the DfES acoustics website www.teachernet.gov.uk/acoustics.)

Assumptions to be made in the assessment of speech intelligibility are:

- for students, when seated, the head height (for listening or speaking) is 0.8 m for nursery schools, 1.0 m for primary schools and 1.2 m for secondary schools
- for students, when standing, the head height (for listening or speaking) is 1.0 m for nursery schools, 1.2 m for primary schools and 1.65 m for secondary schools
- for teachers, when seated, the head height (for listening or speaking) is 1.2 m
- for teachers, when standing, the head height (for listening or speaking) is 1.65 m
- the background noise level is the overall noise level due to all activities (including teaching and study) in the open-plan space.

1.2 Demonstrating compliance to the Building Control Body

The preferred means of demonstrating compliance to the Building Control Body is to submit a set of plans, construction details, material specifications, and calculations, as appropriate for each area of the school which is covered by Requirement E4 of the Building Regulations.

The plans should identify:

- the highest estimate for the indoor ambient noise level, $L_{Aeq,30min}$, in each space and the appropriate upper limit from Table 1.1
- the estimated weighted BB93 standardized level difference, $D_{nT}(T_{mf,max}),w$, between spaces and the appropriate minimum value from Table 1.2
- the proposed values of R_w for partition walls and for doors, $D_{n,e,w} - 10\lg N$ for

ventilators between circulation spaces and other spaces used by students, and the appropriate minimum values from Table 1.3

- the estimated weighted BB93 standardized impact sound pressure level, $L'_{nT}(T_{mf,max}),w$, of floors above spaces and the appropriate maximum values from Table 1.4
- the estimated value of mid frequency reverberation time T_{mf} in each space and the appropriate range of values from Table 1.5
- the proposed absorption treatments in corridors, entrance halls and stairwells
- for open plan spaces, the estimated range of STI values for speech communication from teacher to student, student to teacher and student to student.

The supporting information should include:

- construction details and material specifications for the external building envelope
- construction details and material specifications for all wall and floor constructions, including all flanking details
- calculations of the sound insulation $D_{nT}(T_{mf,max}),w$ and $L'_{nT}(T_{mf,max}),w$
- calculations of reverberation times in teaching and study spaces
- calculations of the absorption area to be applied in corridors, entrance halls and stairwells
- measurements and/or calculations demonstrating how rain noise has been controlled
- sound insulation test reports (laboratory and/or field)
- sound absorption test reports (laboratory)
- activity plan and layout for open-plan spaces.

An example of a submission to a Building Control Body, with explanatory notes, is contained in Appendix 10.

1.2.1 Alternative performance standards

In some circumstances alternative performance standards may be appropriate for specific areas within individual schools for particular

educational, environmental or health and safety reasons. In these cases, the following information should be provided to the Building Control Body:

- a written report by a specialist acoustic consultant, clearly identifying (a) all areas of non-compliance with BB93 performance standards (b) the proposed alternative performance standards and (c) the technical basis upon which these alternative performance standards have been chosen
- written confirmation from the educational provider (eg school or Local Education Authority) of areas of non-compliance, together with the justification for the need and suitability of the alternative performance standards in each space.

1.3 Demonstrating compliance to the client

To ensure that the performance standards are met, it is recommended that the client should include a requirement for acoustic testing in the building contract.

The design calculations submitted to the Building Control Body demonstrate only that the construction has the potential to meet the performance standards in Section 1.1. In practice, the performance of the construction is strongly influenced by workmanship on site. If the design calculations and detailing are correct, the most likely causes of failure to meet the performance standards will be poor workmanship, product substitution and design changes on site. Therefore, acoustic testing is recommended.

The DfES acoustics website (www.teachernet.gov.uk/acoustics) will be used to encourage manufacturers and others to disseminate acoustic test results alongside construction details for constructions that consistently satisfy the performance standards.

1.3.1 Timetabling of acoustic testing

Timetabling of acoustic testing is important because any test that results in a failure to satisfy the performance standards will require remedial work to rectify the failure and potential design

changes to other parts of the building. For this reason it is desirable, where possible, to complete a sample set of rooms in the school for advance testing.

1.3.2 Remedial treatments

Where the cause of failure is attributed to the construction, other rooms that have not been tested may also fail to meet the performance standards. Therefore, remedial treatment may be needed in rooms other than those in which the tests were conducted. The efficacy of any remedial treatment should be assessed through additional testing.

1.3.3 Indoor ambient noise levels in unoccupied spaces

To demonstrate compliance with the values in Table 1.1, measurements of indoor ambient noise levels should be taken in at least one in four rooms intended for teaching and/or study purposes, and should include rooms on the noisiest façade. These rooms should be finished and unoccupied but may be either furnished or unfurnished. Measurements should be made when external noise levels are representative of conditions during normal school operation.

During measurements, the following should apply:

- Building services (eg ventilation system, plant) should be in use during the measurement period.
- For mechanically ventilated rooms, the plant should be running at its maximum design duty.
- For naturally ventilated rooms, the ventilators or windows should be open as required to provide adequate ventilation.
- There should be no more than one person present in the room. (The values in Table 1.1 allow for one person to be present in the room during the test)
- There should be dry weather conditions outside.

Measurements of $L_{Aeq,T}$ should be made at least 1 m from any surface of the room and at 1.2 m above floor level in at least three positions that are normally occupied during teaching or study periods. A sound level meter complying

with BS EN 60804:2001 (IEC 60804:2001)^[9] should be used. Further information on noise measurement techniques is available in the Association of Noise Consultants Guidelines on Noise Measurement in Buildings^[10].

Where there is negligible change in noise level over a teaching period, measurements of $L_{Aeq,T}$ over a time period much shorter than 30 minutes (eg $L_{Aeq,5min}$) can give a good indication of whether the performance standard in terms of $L_{Aeq,30min}$ is likely to be met. However, if there are significant variations in noise level, for example due to intermittent noise events such as aircraft or railways, measurements should be taken over a typical 30 minute period in the school day.

1.3.4 Airborne sound insulation between spaces

To demonstrate compliance with the values in Table 1.2, measurements of airborne sound insulation should be taken between vertically and horizontally adjacent rooms where the receiving room is intended for teaching and/or study purposes. At least one in four rooms intended for teaching and study purposes should be tested. Measurements should be taken in the direction with the more stringent airborne sound insulation requirement.

During measurements, the ventilators or windows should be open as required to provide adequate ventilation in both the source room and the receiving room.

Measurements should be made in accordance with BS EN ISO 140-4:1998^[1] and the additional guidance in Approved Document E^[7] Annex B, paragraphs B2.3 – B2.8. Performance should be rated in accordance with BS EN ISO 717-1:1997^[2].

1.3.5 Airborne sound insulation between circulation spaces and other spaces used by students

It is not intended that field measurements should be taken between circulation spaces and other spaces used by students. Laboratory data for the wall, doorsets (if any) and ventilators (if any) should be

presented as evidence of compliance with the values in Table 1.3.

1.3.6 Impact sound insulation

To demonstrate compliance with the values in Table 1.4, measurements of impact sound insulation should be taken between vertically adjacent rooms, where the receiving room is intended for teaching and study purposes. At least one in four teaching/study rooms below a separating floor should be tested.

Measurements should be made in accordance with BS EN ISO 140-7:1998^[5]. Performance should be rated in accordance with BS EN ISO 717-2:1997^[6].

Impact sound insulation should be measured on floors without a soft covering (eg carpet, foam backed vinyl), except in the case of concrete structural floor bases where the soft covering is an integral part of the floor.

1.3.7 Reverberation in teaching and study spaces

To demonstrate compliance with the values in Table 1.5, measurements of reverberation time should be taken in at least one in four rooms intended for teaching and study purposes.

One person may be present in the room during the measurement.

Depending upon the completion sequence for spaces within the school, it may be possible to reduce the measurement effort by utilising measurements of reverberation time that are required as part of airborne or impact sound insulation measurements. For this reason, two measurement methods, described below, are proposed for the measurement of reverberation time. For the purpose of demonstrating compliance, either method can be used to assess whether the performance standards have been met. If one method demonstrates compliance with the performance standard and the other demonstrates failure, then the performance standard should be considered to have been met.

Measurement method 1: Measurements should be made in accordance with either low coverage or normal coverage

measurements described in BS EN ISO 3382:2000^[11].

Measurement method 2: Reverberation time measurements should be made in accordance with BS EN ISO 140-4:1998^[1] (airborne sound insulation) or BS EN ISO 140-7:1998^[5] (impact sound insulation) in octave bands.

1.3.8 Sound absorption in corridors, entrance halls and stairwells

It is not intended that field measurements of reverberation time should be taken in corridors, entrance halls and stairwells.

1.3.9 Speech intelligibility in open-plan spaces

To demonstrate compliance with the values in Table 1.6, measurements of the Speech Transmission Index (STI) should be taken in at least one in ten student positions in the open-plan spaces.

Measurements should be made in accordance with BS EN 60268-16:1998^[8].

Measurements should be made using the following heights for listening or speaking:

- to represent seated students, a head height of 0.8 m for nursery schools, 1.0 m for primary schools and 1.2 m for secondary schools
- to represent standing students, a head height of 1.0 m for nursery schools, 1.2 m for primary schools and 1.65 m for secondary schools
- to represent seated teachers, a head height of 1.2 m
- to represent standing teachers, a head height of 1.65 m.

Simulation of the estimated occupancy noise should be carried out in the STI measurement. This noise level will have been established at the design stage (see Section 1.1.7) and is defined as the noise level due to the combination of the indoor ambient noise level, all activities in the open-plan space (including teaching and study), and transmitted noise from adjacent spaces.

References

- [1]** BS EN ISO 140-4:1998 Acoustics – Measurement of sound insulation in buildings and of building elements. Part 4. Field measurements of airborne sound insulation between rooms.
- [2]** BS EN ISO 717-1:1997 Acoustics – Rating of sound insulation in buildings and of building elements. Part 1. Airborne sound insulation.
- [3]** BS EN ISO 140-3:1995 Acoustics – Measurement of sound insulation in buildings and of building elements. Part 3. Laboratory measurement of airborne sound insulation of building elements.
- [4]** BS EN 20140-10:1992 Acoustics – Measurement of sound insulation in buildings and of building elements. Part 10. Laboratory measurement of airborne sound insulation of small building elements.
- [5]** BS EN ISO 140-7:1998 Acoustics – Measurement of sound insulation in buildings and of building elements. Part 7. Field measurements of impact sound insulation of floors.
- [6]** BS EN ISO 717-2:1997 Acoustics – Rating of sound insulation in buildings and of building elements. Part 2. Impact sound insulation.
- [7]** Approved Document E – Resistance to the passage of sound. Stationery Office 2003. ISBN 0 11 753 642 3. www.odpm.gov.uk
- [8]** BS EN 60268-16:1998 Sound system equipment – Part 16: Objective rating of speech intelligibility by speech transmission index.
- [9]** BS EN 60804:2001 (IEC 60804:2001) Integrating-averaging sound level meters.
- [10]** Guidelines on Noise Measurement in Buildings, Part 1: Noise from Building Services and Part 2: Noise from External Sources. Association of Noise Consultants.
- [11]** BS EN ISO 3382:2000 Acoustics – Measurement of the reverberation time of rooms with reference to other acoustical parameters.

Section 2 gives recommendations and guidance concerning noise control, starting with the choice of a site and the control of external noise. Local government planning policy will be influenced by the recommendations on maximum external noise levels in playing fields and other external areas used by the school. Section 2 also includes discussion of the means of controlling indoor ambient noise.

2.1 Choosing a site

The acoustic design of a school starts with the selection of the site, a noise survey of the site and planning the layout of the school buildings.

Economic sites for new schools with easy access to transport often suffer from traffic noise and pollution. In the past, schools have sometimes been built on sites which would not normally have been considered suitable for housing. This has been in part because schools have not always been recognised as requiring particularly high environmental standards, and in part because there has been less formal control or regulation of noise levels in schools than for housing.

Where school sites are adjacent to busy roads they will require the use of intelligent design, zoning, noise screening and, if necessary, sound insulating building envelopes together with mechanical ventilation or acoustically designed passive ventilation.

Many of the acoustic problems in existing schools derive directly from the school's location in a noisy area. For existing schools, noise from road traffic is a common problem, but in some areas noise from railways and aircraft is intrusive^[1]. Noise from industrial and leisure sources is a less frequent problem and can normally be dealt with at source by the Local Authority using their powers under the Environmental Pollution Act.

2.2 Recommendations for external noise levels outside school buildings

Although Requirement E4 does not apply to external noise, the following recommendations are considered good practice for providing good acoustic

conditions outside school buildings.

For new schools, 60 dB $L_{Aeq,30min}$ should be regarded as an upper limit for external noise at the boundary of external premises used for formal and informal outdoor teaching, and recreational areas.

Under some circumstances it is possible to meet the specified indoor ambient noise levels on sites where external noise levels are as high as 70 dB $L_{Aeq,30min}$ but this will require considerable building envelope sound insulation, screening or barriers.

Noise levels in unoccupied playgrounds, playing fields and other outdoor areas should not exceed 55 dB $L_{Aeq,30min}$ and there should be at least one area suitable for outdoor teaching activities where noise levels are below 50 dB $L_{Aeq,30min}$. If this is not possible due to a lack of suitably quiet sites, acoustic screening should be used to reduce noise levels in these areas as much as practicable, and an assessment of predicted noise levels and of options for reducing these should be carried out.

Playgrounds, outdoor recreation areas and playing fields are generally considered to be of relatively low sensitivity to noise, and indeed playing fields may be used as buffer zones to separate school buildings from busy roads where necessary.

However, where used for teaching, for example sports lessons, outdoor ambient noise levels have a significant impact on communication in an environment which is already acoustically less favourable than most classrooms. Ideally, noise levels on unoccupied playing fields used for teaching sport should not exceed 50 dB $L_{Aeq,30min}$. If this is not possible at all locations, there should be at least one area

at which noise levels are below 50 dB $L_{Aeq,30min}$ so that some outdoor teaching is possible.

Acoustic screening from fences, walls or buildings may be used to protect playgrounds from noise. At positions near the screen, traffic noise can be reduced by up to 10 dB(A).

All external noise levels in this section apply to measurements made at approximately head height and at least 3 m from any reflecting surface other than the ground.

2.3 Noise survey

Figure 2.1 shows typical external and internal sources of noise which can affect noise levels inside a school.

In order to satisfy the limits for the indoor ambient noise levels in Table 1.1, it is necessary to know the external noise level so that the building envelope can be designed with the appropriate sound insulation.

The external noise level should be established by carrying out a noise measurement survey. (Note that a brief survey is advisable even if the site appears to be quiet, in case there are noisy events at certain times of the day.) The measurements should be taken during

typical school hours and include noisy events (eg road traffic at peak hours, worst case runway usage in the case of airports, etc). The measurements must also take account of the weather conditions. For long-distance propagation of noise, the measured level is affected by wind gradients, temperature gradients and turbulence. With wind, the noise level is generally increased downwind or reduced upwind. (Note that temperature inversions can radically change noise propagation, but tend to occur only at night-time, outside school hours.)

A noise measurement survey must include octave or one-third octave frequency band levels. This is because the attenuation of sound, for example by a sound insulating wall or noise barrier, depends upon the frequency of sound. In general materials and barriers are less effective at controlling low frequency noise than mid and high frequency noise. Although overall noise levels and performance standards can be quoted as overall A-weighted levels, calculations must be carried out in octave or one-third octave bands (see Appendix 1) and the results converted into overall A-weighted levels.

In addition to the noise measurement

Figure 2.1: Typical sources of noise

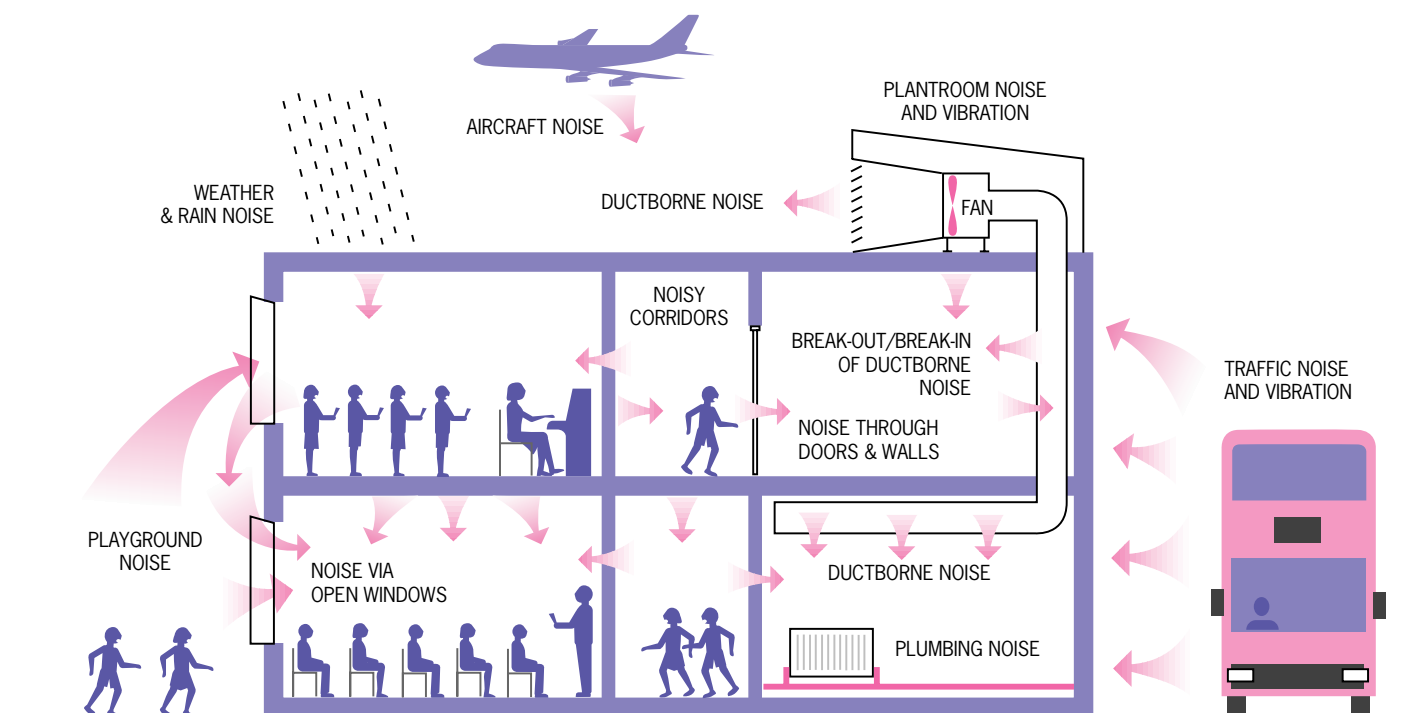

survey, consideration should be given to predicting the potential increases in noise levels due to future developments (eg increases in traffic flows, new transport schemes, changes in flight paths). The local highway authority should be able to advise on whether significant changes in road traffic noise are expected in the future. This is likely to be relevant for developments near new or recently improved roads. Where road traffic noise levels are likely to increase, it is reasonable to base the sound insulation requirements on the best estimate of noise levels in 15 years time. Similar information is likely to be available from railway operators, and airports. The prediction^[2,3] of future external noise levels should be carried out by an acoustic consultant.

If the noise measurement survey shows that the ambient external noise levels on the site are below 45 dB $L_{Aeq,30min}$ and prediction work shows that they will remain below 45 dB $L_{Aeq,30min}$ in the future, no special measures are likely to be necessary to protect the buildings or playing fields from external noise.

2.4 Road and rail noise

Sources of road and rail noise require individual assessment because of their characteristics.

Road traffic noise is a function of traffic flow, percentage of heavy goods vehicles, traffic speed gradient (rate of acceleration), road surface and propagation path of the noise.

Rail noise is a function of train type, number, speed, rail type and propagation path of the noise.

In general it is advisable to locate a school at least 100 m away from busy roads and railways, but in towns and cities this is often not possible. However, the use of distance alone is a relatively ineffective way to reduce noise. Simple rules of thumb are that the noise level from a busy road increases by 3 dB(A) for a doubling of the traffic flow and decreases by 3 dB(A) for a doubling of distance from the road (over hard ground).

2.5 Aircraft noise

Where a school is to be located in an area affected by aircraft noise, special measures are necessary and an acoustic consultant should be appointed.

2.6 Vibration

Railways, plant and heavy vehicles close to a school can lead to vibration within the school buildings. This vibration can re-radiate as audible noise, even when the vibration itself is not perceptible as shaking in the building. The propagation of vibration depends on ground conditions but in general when planning a new school building it is advisable for the noise survey to include vibration measurements when there is a railway within 30 m of a building, or a road with significant HGV traffic within 20 m. In these cases airborne noise is also likely to be a problem.

Figure 2.2: Attenuation by a noise barrier as a function of path difference

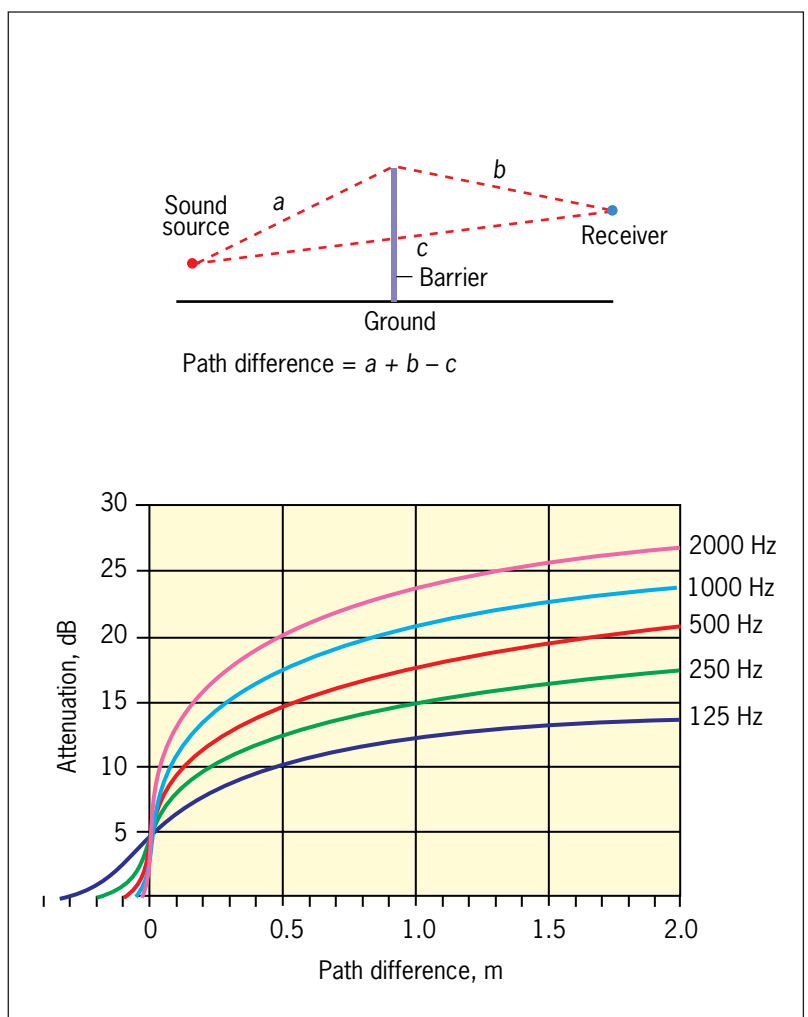

2.7 Noise barriers

Noise barriers are much more effective than distance in reducing noise from road or rail traffic. In its simplest form a noise barrier can be a continuous close-boarded wooden fence, with a mass of not less than 12 kg/m^2 . There is relatively little point in increasing the weight of the barrier beyond this because a significant proportion of the noise passes over the top (or round the ends) of the barrier.

The attenuation of a barrier is a function of the path difference, that is the extra distance that the sound has to travel to pass over the top of the barrier, see Figure 2.2. Barriers are less effective at reducing low frequency noise than mid and high frequency noise. Hence, to calculate the effectiveness of a noise barrier it is necessary to know the source noise levels in octave or one-third octave bands (see Appendix 1).

Hedges or single trees (or rows of trees) do not in themselves make effective noise barriers. A common and effective solution is a wooden fence to act as a noise barrier, located within a band of trees to create an acceptable visual effect.

Barriers can also be formed by other buildings or by landscaping using earth bunds, see Figure 2.3. The path difference, and hence the attenuation, will

be affected by whether the road or railway is in a cutting or on an embankment.

2.8 Noise from schools to surrounding areas

Noise from schools to the surrounding area can also be a problem, and consideration should be given to nearby residential and other noise-sensitive developments which could be disturbed by noise from playgrounds, playing fields, music rooms and halls used for events such as after school concerts and discos. The local planning authority will normally consider this in assessing any planning application for new schools or extensions to existing premises.

The effect of playground noise on children inside parts of the school near the playground should also be considered as part of the design.

2.9 Planning and layout

Among the most common problems found in schools is noise transfer between rooms. To a large extent this can be designed out without resort to very high performance sound insulating walls or floors, but by good planning and zoning of the building at the earliest stages of design. At this stage it is possible to identify noise-sensitive areas and to

Figure 2.3: Traffic noise barriers

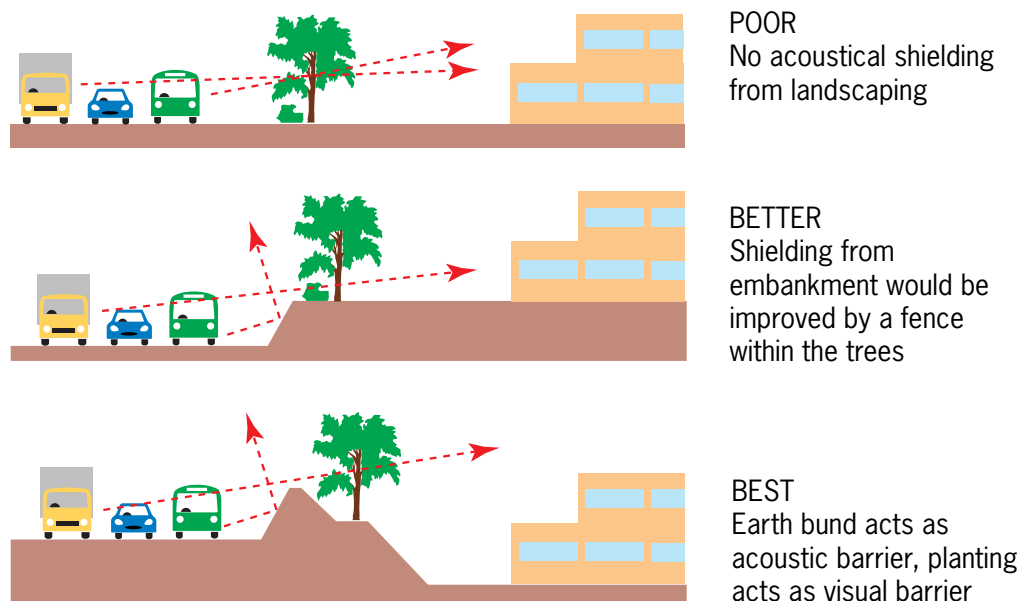

possible in order to minimise noise levels in these areas. The requirement is to provide sound absorption in accordance with Section 1.1.6. To satisfy this requirement, corridors outside classrooms typically need acoustically absorbent ceilings and/or wall finishes. Carpets and other soft floor finishes can also help to reduce reverberation and the noise from footfalls. However, as discussed in Section 2.11, the use of carpets may not be appropriate in all schools.

2.13 Masking noise

The audibility and intrusiveness of noise from other areas (break-in noise) is a function of both the level of the break-in noise and the noise level in the room under consideration (the receiving room). If the ambient noise level in the receiving room is unnecessarily low, break-in noise will be more audible. Hence where rooms are mechanically ventilated, the noise from the ventilation system can be used to mask the noise from activities in neighbouring rooms. In these cases ventilation noise should not be more than 5 dB below the maximum ambient noise levels listed in Table 1.1. For this type of masking to work it is important to ensure that the ventilation noise follows a specific masking noise curve and has no tonal or intermittent characteristics. Specialist acoustic advice is required before using building services noise for masking.

Other possible sources of masking noise are fan convectors, electric lighting circuits, and constant levels of road traffic noise, for example from distant arterial roads. However it should be noted that the noise from some sources (eg fans and other mechanical equipment) may cause annoyance to individuals, particularly hearing impaired people, in some circumstances. Also, some building services systems may only operate at certain times of the year.

2.14 Low frequency noise and hearing impaired pupils

Many hearing impaired pupils make use of low frequencies below 500 Hz to obtain information from speech.

Therefore, for hearing impaired pupils to be included in classes with pupils having normal hearing, special care should be taken to minimise low frequency indoor ambient noise levels. Given the prevalence of infections leading to temporary hearing loss, it is advisable to minimise low frequency indoor ambient noise levels in all classrooms, especially those used by younger pupils.

The indoor ambient noise levels in Table 1.1 are given in terms of $L_{Aeq,30min}$ which is an A-weighted noise level. This is a convenient and widely-used parameter but is not a good indicator of low frequency noise. To assess indoor noise there are other rating systems in use which address low frequency noise but these are beyond the scope of this document. In cases where low frequency noise is likely to be a problem, specialist advice from an acoustics consultant should be sought. Such cases include schools exposed to high levels of external noise (in excess of 60 dB $L_{Aeq,30min}$, see Section 2.2), where sound insulation may reduce high frequency noise while leaving comparatively high levels of low frequency noise.

More information is given in CIBSE Guide B5 Noise and Vibration Control for HVAC.^[4]

References

- [1] B Shield, J Dockrell, R Jeffery and I Tachmatzidis. The effects of noise on the attainments and cognitive performance of primary school children. Department of Health, 2002.
- [2] Calculation of road traffic noise (CRTN), Department of Transport, The Stationery Office, 1988.
- [3] Calculation of railway noise (CRN), (Supplement 1), Department of Transport, The Stationery Office, 1995.
- [4] CIBSE Guide B5, Noise and vibration control for HVAC, CIBSE, 2002 ISBN 1 903287 2 51.

General principles of sound insulation and typical constructions are discussed in this section. Space does not allow all details for each type of construction to be shown. Many such details are illustrated and discussed in greater detail in *Approved Document E*^[1]. Further guidance and illustrations are also available in *Sound Control for Homes*^[2] and in manufacturers' literature for proprietary materials and systems.

3.1 Roofs

The sound insulation of a pitched roof depends upon the mass of the ceiling and the roof layers and the presence of a sound absorbing material in the roof space. Mineral wool, used as thermal insulation in the ceiling void, will also provide some acoustic absorption, which will have a small effect on the overall sound insulation of a roof. A denser specification of mineral wool, as commonly used for acoustic insulation, would have a greater effect on the overall sound insulation of the roof.

Where it is necessary to ventilate the roof space, it is advisable to make any necessary improvements to the sound insulation by increasing the mass of the ceiling layer, which should be airtight. Recessed light fittings can make this difficult and sometimes it is better to place the sound insulating material below the roof covering and to extend partition walls up to the roof layer (providing adequate ventilation can be maintained).

3.1.1 Rain noise

The impact noise from rain on the roof can significantly increase the indoor noise level; in some cases the noise level inside a school due to rain can be as high as 70 dB(A).

Although rain noise is excluded from the definition of indoor ambient noise in

Section 1.1, it is a potentially important noise source which must be considered at an early point in the roof design to minimise disturbance inside the school.

Excessive noise from rain on the roof can occur in spaces (eg sports halls, assembly halls) where the roof is made from profiled metal cladding and there is no sealed roof space below the roof to attenuate the noise before it radiates into the space below. With profiled metal cladding, the two main treatments that should be used in combination to provide sufficient resistance to impact sound from rain on the roof are:

- damping of the profiled metal cladding (eg using commercial damping materials)
- independent ceilings (eg two sheets of 10 kg/m² board material such as plasterboard, each supported on its own frame and isolated from the profiled metal cladding, with absorptive material such as mineral fibre included in the cavity.)

Profiled metal cladding used without a damping material and without an independent ceiling is unlikely to provide sufficient resistance to impact sound from rain on the roof. A suitable system that could be used in schools is shown in Figure 3.1. The performance of such a system was measured by McLoughlin et al^[3].

Prediction models are available to predict the noise radiated from a single sheet of material; however, a single sheet will not provide sufficient attenuation of impact noise from rain. Suitable lightweight roof constructions that do provide sufficient attenuation will consist of many layers. For these multi-layer roof constructions, laboratory measured data for the entire roof construction is needed. At the time of writing, a new laboratory

Figure 3.1: Profiled metal clad roof incorporating acoustic damping

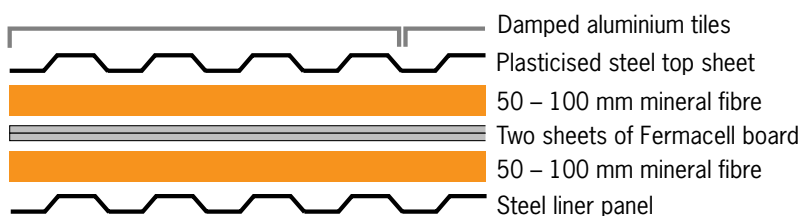

measurement standard for impact sound from rain on the roof, ISO 140-18^[4], is under development. In the future this will allow comparison of the insulation provided by different roof, window and glazing elements and calculation of the sound pressure level in the space below the roof.

When designing against noise from rain on the roof, consideration should also be given to any glazing (eg roof lights) in the roof. Due to the variety of different roof constructions, advice should be sought from an acoustic consultant who can calculate the sound pressure level in the space due to typical rainfall on the specific roof.

3.2 External Walls

For masonry walls, such as a 225 mm solid brick wall, a brick/block cavity wall or a brick-clad timber frame wall, the sound insulation performance will normally be such that the windows, ventilators and, in some cases, the roof will dictate the overall sound insulation of the building envelope.

Timber frame walls with lightweight cladding and other lightweight systems of construction normally provide a lower standard of sound insulation at low frequencies, where road traffic and aircraft often produce high levels of noise. This can result in low airborne sound insulation against these noise sources unless the cladding system has sufficient low frequency sound insulation. The airborne sound insulation can be assessed from laboratory measurements carried out according to BS EN ISO 140-3:1995^[5].

3.3 Ventilation

The method of ventilation as well as the type and location of ventilation openings will affect the overall sound insulation of the building envelope. When external noise levels are higher than 60 dB $L_{Aeq,30min}$, simple natural ventilation solutions may not be appropriate as the ventilation openings also let in noise. However, it is possible to use acoustically attenuated natural ventilation rather than full mechanical ventilation when external noise levels are high but do not exceed

70 dB $L_{Aeq,30min}$.

The School Premises Regulations^[6] require that:

“All occupied areas in a school building shall have controllable ventilation at a minimum rate of 3 litres of fresh air per second for each of the maximum number of persons the area will accommodate.

All teaching accommodation, medical examination or treatment rooms, sick rooms, sleeping and living accommodation shall also be capable of being ventilated at a minimum rate of 8 litres of fresh air per second for each of the usual number of people in those areas when such areas are occupied.”

In densely occupied spaces such as classrooms, 8 litres per second per person is the minimum amount of fresh air that should be provided by a natural or mechanical ventilation system under normal working conditions, in order to maintain good indoor air quality.

In order to satisfy the limits for the indoor ambient noise levels in Table 1.1, it is necessary to consider the sound attenuation of the ventilation openings so that the building envelope can be designed with the appropriate overall sound insulation. In calculations of overall sound insulation the attenuation assumed for the ventilation system should be for normal operating conditions.

The main choices for the natural ventilation of typical classrooms are shown in Figure 3.2. Case Studies 7.8 and 7.9 describe the recent application of two of these design solutions in new secondary school buildings.

Additional ventilation such as openable windows or vents may be required to prevent summertime overheating.

3.3.1 Ventilators

Passive ventilators normally penetrate the walls, but in some cases they penetrate the window frames (eg trickle ventilators) or the windows themselves. Often windows are not used as intended as they cause uncomfortable draughts. For this reason, increased use is being made of purpose designed ventilation systems with or without acoustic attenuation.

Many proprietary products are

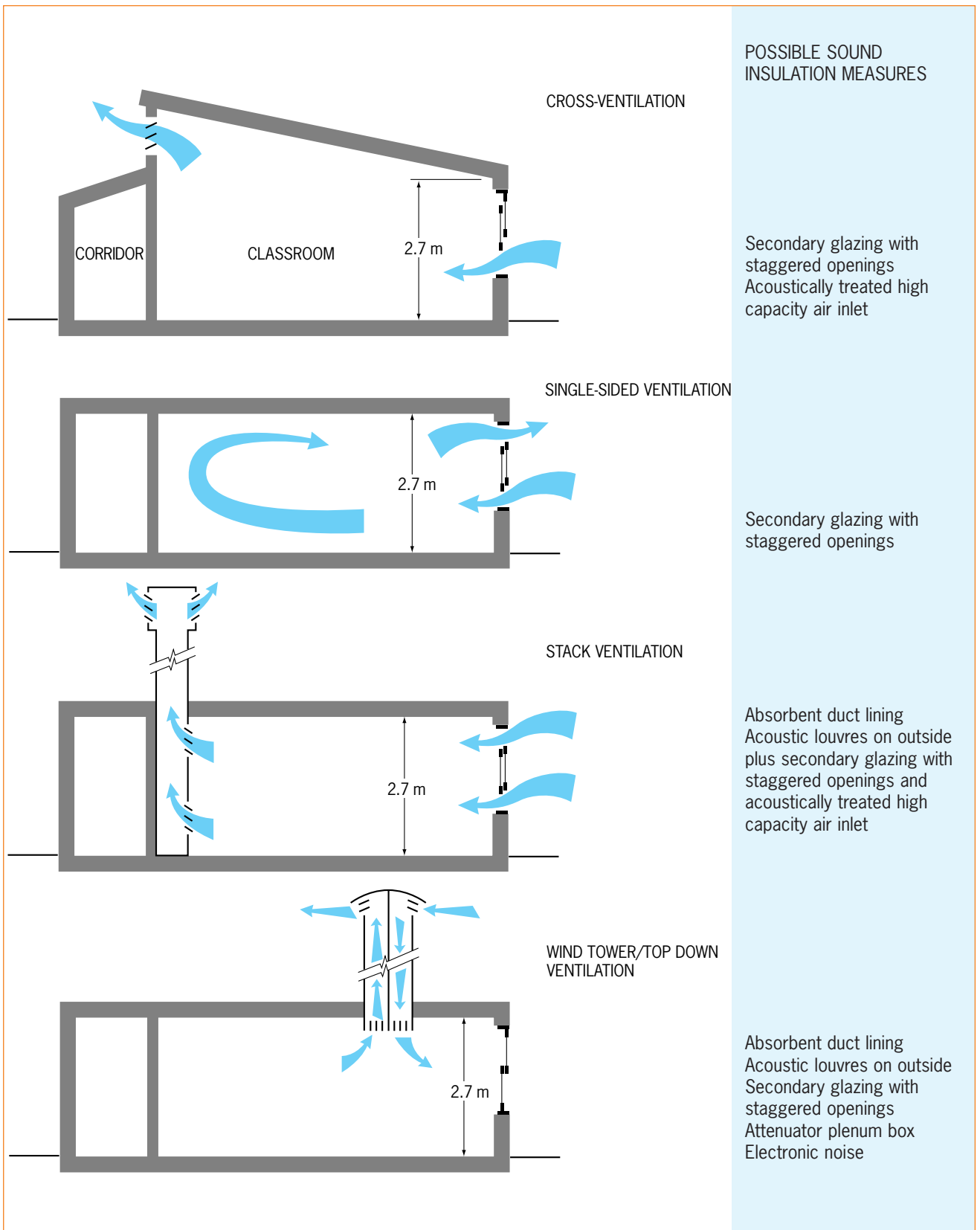

Figure 3.2: Possible types of natural ventilation

designed for the domestic sector and in some cases they do not have large enough openings for classrooms and other large rooms found in schools. The acoustic performance of any ventilator can be assessed with laboratory sound insulation test data measured according to BS EN 20140-10:1992^[7]. Because of the complexity of the assessment of the acoustic performance of a ventilator, advice may be needed from a specialist acoustic consultant. To maintain adequate ventilation, it is essential that the effective area of the ventilator is considered as it may be smaller than the free area (see prEN 13141-1^[8]).

It is important, particularly in the case of sound-attenuated products, that a good seal is achieved between the penetration through the wall or window and the ventilator unit. Where through-the-wall products are used, the aperture should be cut accurately and the gap around the perimeter of the penetrating duct should be packed with sound insulating material prior to application of a continuous, flexible, airtight seal on both sides.

In some schools bespoke ventilator designs, such as that shown in Figure 3.3, are needed. For more examples of ventilator solutions see Case Studies 7.8 and 7.9.

3.4 External Windows

The airborne sound insulation of windows can be assessed from laboratory measurements of the sound reduction index according to BS EN ISO 140-3:1995^[5]. When choosing suitable windows using measured data, care must be taken to differentiate between measured data for glazing and measured data for windows. The reason is that the overall sound insulation performance of a window is affected by the window frame and the sealing as well as the glazing.

To achieve the required sound insulation with thin glass it is often necessary to use two panes separated by an air (or other gas) filled cavity. In theory, the wider the gap between the panes, the greater the sound insulation. In practice, the width of the cavity in double glazing makes relatively little

difference for cavity widths between 6 mm and 16 mm. Wider cavity widths perform significantly better.

In existing buildings, secondary glazing may be installed as an alternative to replacing existing single glazing with double glazing. The effectiveness of secondary glazing will be determined by the thickness of the glass and the width of the air gap between the panes. Another alternative may be to fit a completely new double-glazed window on the inside of the existing window opening, leaving the original window intact. The use of sound absorbing reveal linings improves the performance of double-glazed windows, but the improvement is mainly in the middle to high frequency region, where it has little effect on road traffic and aircraft noise spectra.

To achieve their optimum performance, it is essential that the glazing in windows makes an airtight seal with its surround, and that opening lights have effective seals around the perimeter of each frame. Neoprene compression seals will provide a more airtight seal than brush seals. The framing of the window should also be assembled to achieve an airtight construction.

It is equally important that an airtight seal is achieved between the perimeter of the window frame and the opening into which it is to be fixed. The opening should be accurately made to receive the window, and the perimeter packed with sound insulating material prior to application of a continuous seal on both sides.

For partially open single-glazed windows or double-glazed windows with opposite opening panes, the laboratory measured airborne sound insulation is approximately 10-15 dB R_w . This increases to 20-25 dB R_w in the open position for a secondary glazing system with partially open ventilation openings, with the openings staggered on plan or elevation, and with absorbent lining of the window reveals (see Figure 3.3). In situ, the degree of attenuation provided by an open window also depends on the spectrum of the noise and the geometry of the situation.

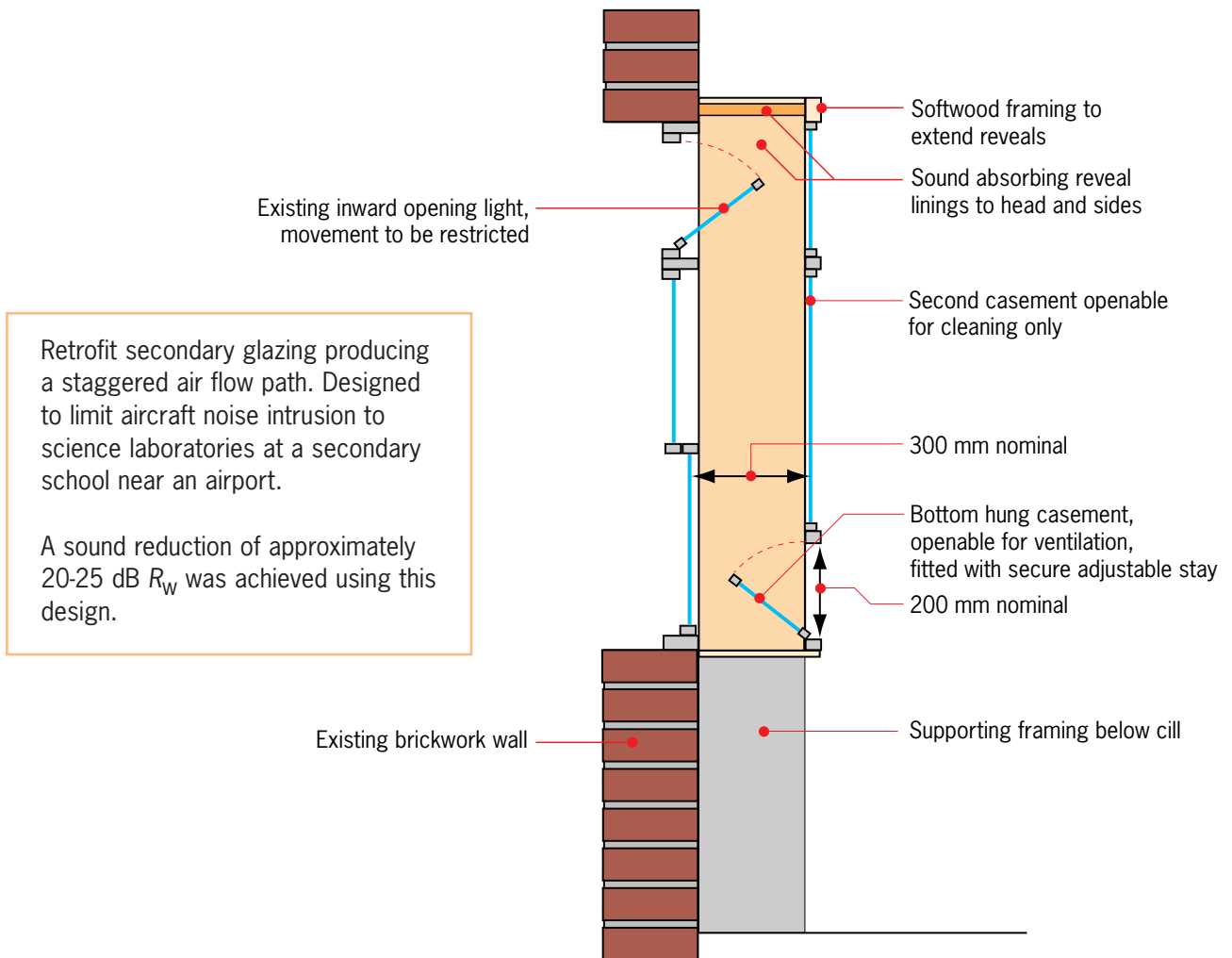

The spreadsheet of sound reduction indices on the DfES acoustic website gives values of R_w for various types of window, glazing thickness, and air gap. Indications are also given of the sound reduction indices of open windows.

3.5 External Doors

For external doors the airborne sound insulation is determined by the door set, which is the combination of door and frame. The quality of the seal achieved around the perimeter of the door is crucial in achieving the potential performance of the door itself. Effective seals should be provided at the threshold, jambs and head of the door frame. As with windows, neoprene compression seals are more effective than brush seals, but their effectiveness will be strongly influenced by workmanship on site. Brush

seals can however be effective and tend to be more hard wearing than compression seals.

It is also important that an airtight seal is achieved between the perimeter of the door frame and the opening into which it is to be fixed. The opening should be accurately made to receive the door frame and any gaps around the perimeter packed with insulating material prior to application of a continuous, airtight seal on both sides.

A high level of airborne sound insulation is difficult to provide using a single door; however, it can be achieved by using a lobby with two sets of doors, as often provided for energy efficiency, or a specialist acoustic doorset.

Figure 3.3: Secondary glazing producing a staggered air flow path

SOUND INSULATION OF THE BUILDING ENVELOPE

There are two methods by which it is possible to calculate the indoor ambient noise levels due to external noise.

The first method is to calculate the indoor ambient noise level according to the principles of BS EN 12354-3:2000^[9]. An Excel spreadsheet to calculate the sound insulation of building envelopes, based on BS EN 12354-3:2000 is available via the DfES acoustics website. The principles of this calculation spreadsheet are given in Appendix 5.

The second method is to calculate the indoor ambient noise level using the measured façade sound insulation data from an identical construction at another site.

3.6 Subjective characteristics of noise

The indoor ambient noise levels in Table 1.1 provide a reasonable basis for assessment, but some noises have tonal or intermittent characteristics which make them particularly noticeable or disturbing, even below the specified levels. This is most common with industrial noise. At a minority of sites, achieving the levels in Table 1.1 will not prevent disturbance from external industrial sources, and additional noise mitigation may be required. In these cases advice from an acoustic consultant should be sought.

The potentially beneficial masking effect of some types of continuous broadband external noise (such as road traffic noise) must also be borne in mind, see Section 2.12. This noise may partially mask other sounds, such as from neighbouring classrooms, which may be more disturbing than the external noise. There are acoustic benefits, as well as cost benefits, in ensuring that the level of insulation provided is not over-specified but is commensurate with the external noise.

3.7 Variation of noise incident on different facades

It may be convenient to determine the external noise level at the most exposed window (or part of the roof) of a

building, and to assume this exposure for other elements too. This may be suitable at the early design stage for large schools. However, where external noise levels vary significantly, this approach can lead to over-specification and unnecessary cost.

3.8 Calculations

A calculation of the internal noise level according to BS EN 12354-3:2000 can be used to estimate whether, for the levels of external noise at any particular site, a proposed construction will achieve the levels in Table 1.1. By estimating the internal levels for various different constructions, designers can determine the most suitable construction in any given situation. BS EN 12354-3:2000 allows the effects of both direct and flanking transmission to be calculated, but in many cases it is appropriate to consider only direct transmission.

3.9 Test method

Field testing of an existing building envelope should be conducted according to BS EN ISO 140-5:1998^[10], with reference to the clarifications given in this section.

BS EN ISO 140-5:1998 sets out various test methods. The three ‘global’ tests using the prevailing external noise source(s) (road traffic, railway traffic, air traffic) are preferable. At most sites road traffic is likely to be the dominant source of noise, and the corresponding standardised level difference is denoted $D_{tr,2m,nT}$. Where aircraft noise is the major concern measurements should be made accordingly, and the standardised level difference denoted $D_{at,2m,nT}$. Similarly the standardised level difference using railway noise as the source is denoted $D_{rt,2m,nT}$.

The global loudspeaker test method (which generates $D_{ls,2m,nT}$ values) may be used only if the prevailing external noise sources are insufficient to generate an adequate internal level.

It is reasonable, under certain conditions as specified below, to use the test results to indicate the likely performance of building envelopes of a similar construction, exposed to similar

sources. If the conditions are not met then it is not reasonable to infer the performance from existing sound insulation test results and the calculation procedure should be used.

3.9.1 Conditions for similar constructions

The following features of any untested construction should be similar to those of the tested construction:

- type and number of ventilators
- glazing specification, frame construction and area of windows
- type and number of doors
- external wall construction and area
- roof construction and area.

3.9.2 Conditions for similar sources

Only test results in terms of $D_{tr,2m,nT}$, $D_{at,2m,nT}$, $D_{rt,2m,nT}$ and $D_{ls,2m,nT}$ values are applicable, and these should not be used interchangeably. The following features concerning the prevailing sources of noise should be similar to those of the previously tested construction:

- relative contributions of road traffic, railway and aircraft noise
- orientation of the building relative to the main noise source(s)
- ground height of the building relative to the main noise source(s).

SOUND INSULATION BETWEEN ROOMS

This section describes constructions capable of achieving the different levels of sound insulation specified in Tables 1.2 and 1.4.

Appendix 3 describes how sound insulation between adjacent rooms is measured and calculated.

In addition to the transmission of direct sound through the wall or floor, additional sound is transmitted into the receiving room via indirect, or 'flanking' paths, see Figure 3.4.

3.10 Specification of the airborne sound insulation between rooms using R_w

Table 1.2 describes the minimum weighted sound level difference between

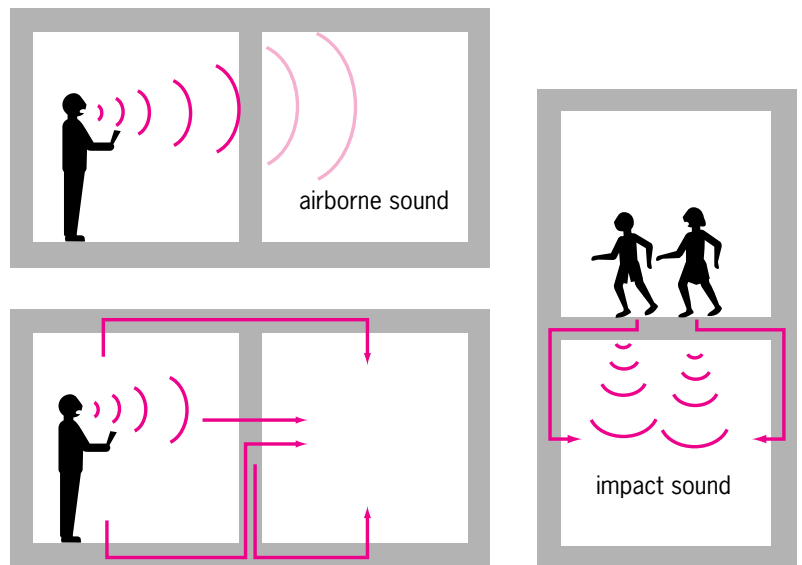

Figure 3.4: Sound transmission paths between adjacent rooms: direct sound paths through the wall and floor and flanking paths through the surrounding ceiling, wall and floor junctions

rooms in terms of $D_{nT}(T_{mf,max})_w$. However, manufacturers provide information for individual building elements based on laboratory airborne sound insulation data measured according to BS EN ISO 140-3:1995^[5], in terms of the sound reduction index, R_w . Figure 3.5 shows the values of R_w for some typical building elements.

This section provides some basic guidance for the designer on how to use laboratory R_w values to choose a suitable separating wall or floor for the initial design. However, specialist advice should always be sought from an acoustic consultant early on in the design stage to assess whether the combination of the separating and flanking walls is likely to achieve the performance standard in Table 1.2. An acoustic consultant can use advanced methods of calculation to predict the sound insulation (eg Statistical Energy Analysis or BS EN 12354-1:2000^[11]). The correct specification of flanking walls and floors is of high importance because incorrect specification of flanking details can lead to reductions in the expected performance of up to 30 dB.

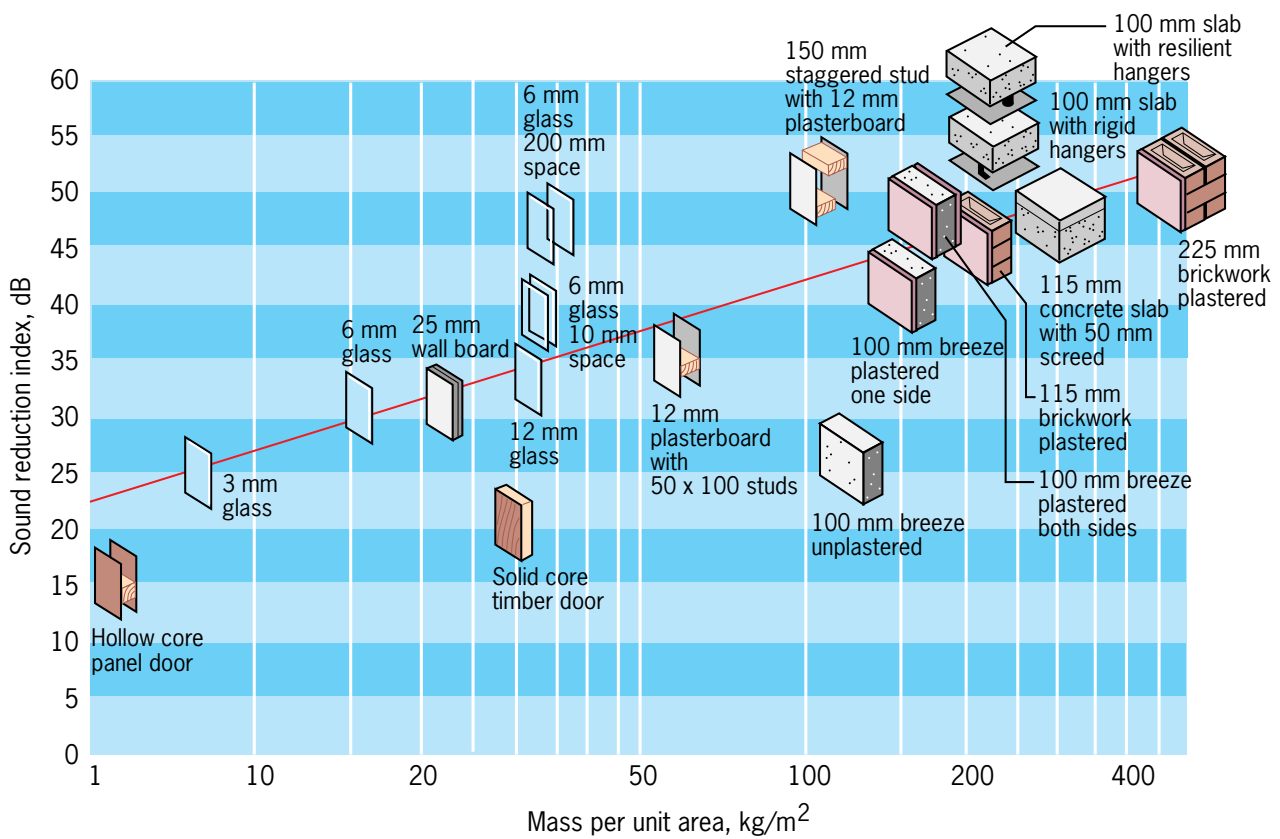

Figure 3.5: Typical sound reduction indices for construction elements

The following procedure can be used to choose an appropriate type of separating wall or floor before seeking specialist advice on appropriate flanking details.

1. From Table 1.2 determine the required minimum weighted BB93 standardized sound level difference between rooms, $D_{nT}(T_{mf,max})_w$.
2. Estimate the required weighted sound reduction index for the separating wall or floor, as follows:
 - a. Use the following formula to provide an initial estimate of the measured sound reduction index ($R_{w,est}$) that should be achieved by the separating wall or floor in the laboratory.

$$R_{w,est} = D_{nT}(T_{mf,max})_w + 10 \lg \left(\frac{ST_{mf,max}}{V} \right) + 8 \text{ dB}$$

where $D_{nT}(T_{mf,max})_w$ is the minimum weighted BB93 standardized level difference between rooms from Table 1.2
 S is the surface area of the separating

element (m^2)

$T_{mf,max}$ is the maximum value of the reverberation time T_{mf} for the receiving room from Table 1.5 (s)

V is the volume of the receiving room (m^3).

- b. Estimate the likely reduction, X dB, in the airborne sound insulation that would occur in the field, to account for less favourable mounting conditions and workmanship than in the laboratory test. X can be estimated to be 5 dB assuming that flanking walls and floors are specified with the correct junction details.

However, if flanking walls and floors are not carefully designed then poor detailing can cause the airborne sound insulation to be reduced by up to 30 dB. To allow the designer to choose a suitable separating wall for the initial design it is recommended that X of 5 dB is assumed and an acoustic consultant is used to check the choice of separating element and ensure that the correct flanking details are specified.

- c. Calculate the final estimate for the

weighted sound reduction index R_w that should be used to select the separating wall or floor from laboratory test data:

$$R_w = R_{w,est} + X \text{ dB}$$

3.10.1 Flanking details

A simplified diagram indicating the main flanking transmission paths is shown in Figure 3.6. General guidance on flanking details for both masonry and framed constructions can be found in Approved Document E^[1]. Specific guidance on flanking details for products can also sometimes be found from manufacturers' data sheets, or by contacting manufacturers' technical advisers.

3.10.2 Examples of problematic flanking details

In some buildings it is considered desirable to lay a floating screed (eg a sand-cement screed laid upon a resilient material) across an entire concrete floor and build lightweight partitions off the screed to form the rooms, see Figure 3.7(a). This allows the flexibility to change the room spaces. However, a continuous floating screed can transmit a significant quantity of structure-borne flanking sound from one room to another.

For example, if a lightweight partition with 54 dB R_w was built off a continuous floating screed the actual sound insulation could be as low as 40 dB

$D_{nT}(T_{mf,max})_w$. In fact, even if a more expensive partition with a higher performance of 64 dB R_w was built, the actual sound insulation would still be 40 dB $D_{nT}(T_{mf,max})_w$, because the majority of sound is being transmitted via the screed, which is the dominant flanking path. This demonstrates the importance of detailing the junction between the screed and the lightweight partition. To reduce the flanking transmission, the floating screed should stop at the lightweight partition, see Figure 3.7(b).

Another flanking detail that can cause problems is where a lightweight profiled metal roof deck runs across the top of a separating partition wall. With profiles such as trapezoidal sections, it is very difficult for builders to ensure that they

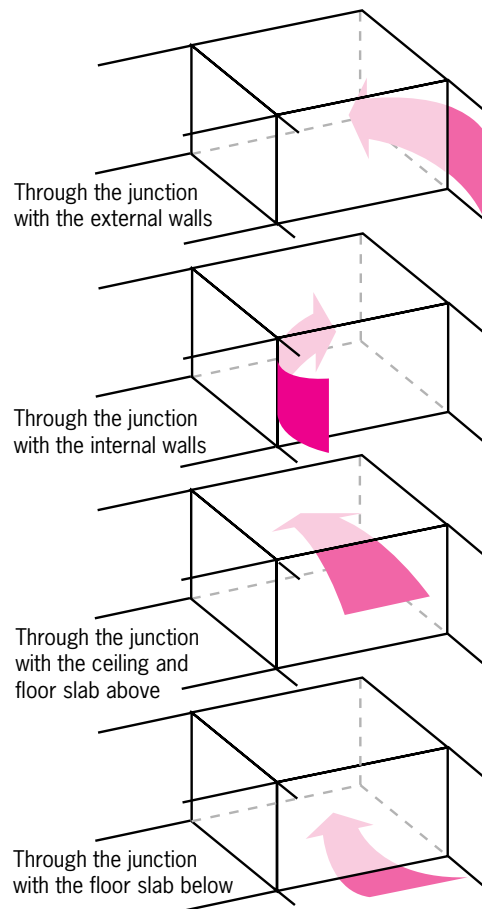

Figure 3.6: The main flanking transmission paths

do not leave air paths between the top of the partition wall and the roof.

3.10.3 Junctions between ceilings and internal walls

Ceilings should be designed in relation to internal walls to achieve the required combined performance in respect of sound insulation, fire compartmentation and support.

In the case of suspended ceiling systems the preferred construction is one in which

Figure 3.7: Flanking transmission via floating screed

(a) Incorrect detail
(b) Correct detail

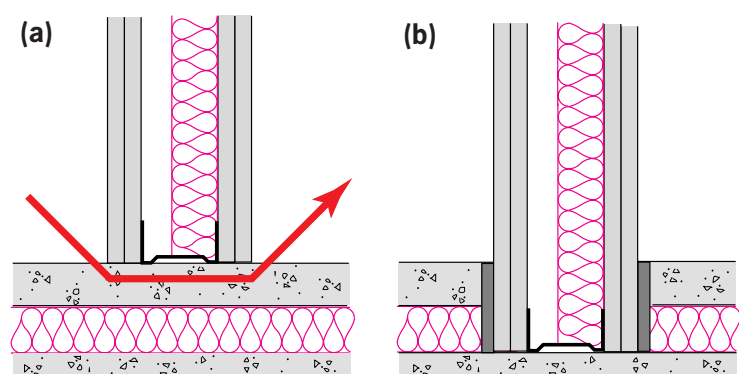

partitions or walls pass through the suspended ceiling membrane, do not require support from the ceiling system, and combine with the structural soffit above to provide fire resisting compartmentation and sound insulation.

The alternative construction in which partitions or walls terminate at, or just above the soffit of a suspended ceiling, is not recommended as it demands a ceiling performance in respect of fire resistance and sound insulation which is difficult to achieve and maintain in practice in school buildings. This is because the number of fittings required at ceiling level is incompatible with testing of fire resistance to BS 476^[12], which is based on a test specimen area of ceilings without fittings. Furthermore, the scale and frequency of access to engineering services in the ceiling void through the membrane (in respect of fire) and through insulation backing the membrane (in respect of sound) is incompatible with maintenance of these aspects of performance.

3.10.4 Flanking transmission through windows

Flanking transmission can occur between adjacent rooms via open windows in the external walls. Side opening casement windows near the separating wall should have their hinges on the separating wall side to minimise airborne sound transmitted from one room to another. Where possible, windows in external walls should be located away from the junction between the external walls and the separating wall or floor. In particular, windows in the external walls of noise sensitive rooms and in the external walls of rooms adjacent to them should be as far as possible from the separating wall or floor.

3.11 Specification of the impact sound insulation between rooms using $L_{n,w}$

Table 1.4 describes the minimum impact sound insulation between rooms in terms of $L'_{nT}(T_{mf,max}),w$. However, manufacturers usually provide information for floors based on laboratory impact sound insulation data measured according

to BS EN ISO 140-6:1998^[13], in terms of $L_{n,w}$.

This section provides some basic guidance for the designer on how to use laboratory $L_{n,w}$ values to design a suitable separating floor. However, specialist advice should always be sought from an acoustic consultant early on in the design process to assess whether the combination of the separating floor and flanking walls is likely to achieve the performance standard in Table 1.4. An acoustic consultant can use advanced methods of calculation to predict the sound insulation (eg Statistical Energy Analysis or BS EN 12354-2:2000^[14]).

The following procedure can be used to choose an appropriate type of separating floor before seeking specialist advice on flanking details from an acoustic consultant.

1. Determine the maximum weighted BB93 standardized impact sound pressure level, $L'_{nT}(T_{mf,max}),w$ from Table 1.4.

2. Estimate the required weighted normalized impact sound pressure level for the separating floor, as follows:

- a. Use the following formula to provide an initial estimate of the weighted normalized impact sound pressure level ($L_{n,w,est}$) that should be achieved by the separating floor in the laboratory:

$$L_{n,w,est} = L'_{nT}(T_{mf,max}),w + 10 \lg \frac{V}{T_{mf,max}} - 18 \text{ dB}$$

where $L'_{nT}(T_{mf,max}),w$ is the maximum weighted BB93 standardized impact sound pressure level from Table 1.4
 V is the volume of the receiving room (m^3)

$T_{mf,max}$ is the maximum value of the reverberation time T_{mf} for the receiving room from Table 1.5 (s).

- b. Estimate the likely increase, X dB, in the impact sound pressure level that would occur in the field to account for less favourable mounting conditions and good workmanship than in the laboratory test.

X can be 5 dB assuming that flanking walls are specified with the correct

junction details. However, if flanking walls are not carefully designed the impact sound pressure level can increase by up to 10 dB. To allow the designer to choose a suitable separating floor for the initial design it is suggested that X of 5 dB is assumed and an acoustic consultant is used to check the choice of separating floor and ensure that the correct flanking details are specified.

c. Calculate the final estimate for the weighted normalised impact sound pressure level $L_{n,w}$ that should be used to select the separating wall or floor from laboratory test data.

$$L_{n,w} = L_{n,w,est} - X \text{ dB}$$

3.12 Internal walls and partitions

3.12.1 General principles

Figure 3.5 shows typical values of the sound reduction index (R_w) for different wall constructions. For comparison the performance of other constructions including doors, glazing and floors is included.

The solid line shows the theoretical value based purely on the mass law. For single leaf elements (eg walls, single glazing, doors, etc) the mass law states that doubling the mass of the element will give an increase of 5 to 6 dB in R_w . When constructions provide less sound insulation than predicted by the mass law it is usually because they are not airtight.

In general, lightweight double-leaf constructions such as double glazing, cavity masonry or double-leaf plasterboard partitions provide better sound insulation than the mass law would indicate. At medium and high frequencies, double-leaf constructions benefit from the separation of the two leaves, with performance increasing with the width of the air gap between the leaves and the physical separation of the leaves. (Note that for double-leaf plasterboard constructions, timber studwork is rarely used to achieve high standards of sound insulation because lightweight metal studs provide better mechanical isolation between the leaves.)

Figure 3.8: Chart to estimate R_w for a composite wall consisting of two elements with different transmission losses

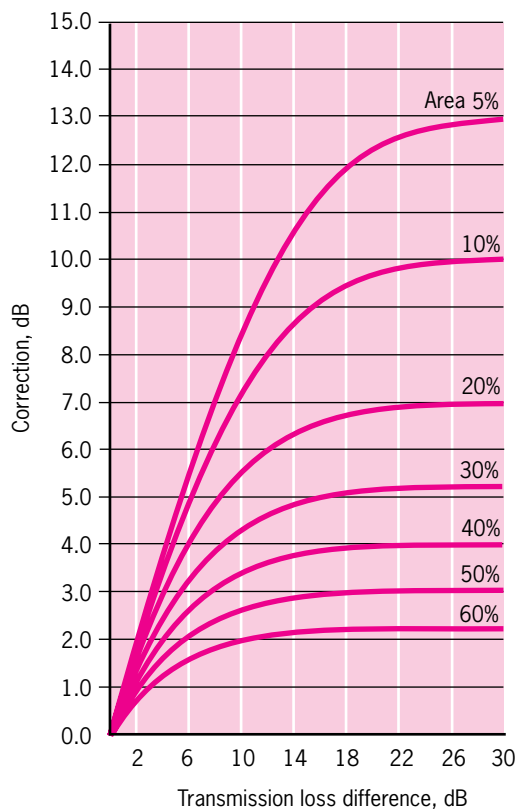

The percentage of the total area of the wall occupied by the element with the lower transmission loss, eg a door, and the difference between the higher R_w and the lower R_w , are used to calculate the correction in dB which is added to the lower R_w to give the R_w of the whole wall.

For example: Assume a classroom to corridor wall has an R_w of 45 dB and a door in the wall has an R_w of 30 dB. If the area of the door is 0.85 m x 2.1 m = 1.785 m² and the area of the wall is 7 m x 2.7 m = 18.9 m², then the percentage of the wall occupied by the door is 1.785/18.9 x 100 = 9.4%

The difference in R_w = 15 dB.

Therefore reading from the chart gives a correction of about 9 dB to be added to the lower R_w , giving a composite R_w of 39 dB.

If a higher performance door of say 35 dB had been used, the composite R_w would be 35 + 7 = 42 dB.

At low frequencies the performance of plasterboard partitions is limited by the mass and stiffness of the partition. Masonry walls can provide better low frequency sound insulation simply because of their mass. This is not obvious from the R_w figures, as the R_w rating system lends more importance to insulation at medium and high frequencies rather than low frequencies. This is not normally a problem in general classroom applications where sound insulation is mainly required at speech frequencies. However, it can be important in music rooms and in other cases where low frequency sound insulation is important.

A combination of masonry and dry-lining can be very effective in providing reasonable low frequency performance with good sound insulation at higher frequencies. This combination is often useful when increasing the sound insulation of existing masonry walls.

While partition walls may be provided as a means of achieving sound reduction, it should be remembered that sound insulation is no better than that provided by the weakest element.

Figure 3.8 can be used to assess the overall effect of a composite construction such as a partition with a window, door, hole or gap in it. The sound insulation of the composite structure is obtained by relating the areas and sound insulation values of the component parts using the graph.

Partitions should be well sealed, as small gaps, holes, etc. significantly reduce sound insulation. (Note that this applies to porous materials, eg porous blockwork, which can transmit a significant amount of sound energy through the pores.)

3.12.2 Sound insulation of common constructions

Figure 3.9 shows the approximate weighted sound reduction index R_w for masonry and plasterboard constructions.

Using the procedures given in Section 3.10, it is possible to determine which constructions are capable of meeting the requirements between different types of rooms.

The values in Figure 3.9 are necessarily approximate and will depend on the precise constructions and materials used. Many blockwork and plasterboard manufacturers provide data for specific constructions.

More sound reduction indices, both single value and octave band data, and further references to specific manufacturers' data are in the sound reduction indices spreadsheet included on the DfES acoustics website.

3.12.3 Flanking transmission

In general, a weighted sound level difference of up to 50 dB $D_{nT}(T_{mf,max}),w$ can be achieved between adjacent rooms by a single partition wall using one of the constructions described above, provided that there are no doors, windows or other weaknesses in that partition wall, and that flanking walls/floors with their junction details are carefully designed. Flanking transmission is critical in determining the actual performance and specialist advice should be sought from an acoustic consultant.

3.12.4 High performance constructions – flanking transmission

High-performance plasterboard partitions or masonry walls with independent linings can provide airborne sound insulation as high as 70 dB R_w in the laboratory. However, to achieve high performance in practice (ie above 50 dB $D_{nT}(T_{mf,max}),w$), flanking walls/floors with their junction details must be carefully designed. Airborne sound insulation as high as 65 dB $D_{nT}(T_{mf,max}),w$ can be achieved on site using high performance plasterboard partitions, or masonry walls with independent linings with lightweight isolated floors and independent ceilings to control flanking transmission. This will require specialist advice from an acoustic consultant.

















For rooms which would otherwise need high-performance partitions it may be possible to use circulation spaces, stores and other less noise-sensitive rooms to act as buffer zones between rooms such that partitions with lower levels of sound insulation can be used. Case Study

Figure 3.9: Walls - airborne sound insulation for some typical wall constructions

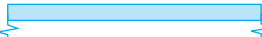
Performance R_w (dB)	Walls - typical forms of construction	
35–40		<p>1x12.5 mm plasterboard each side of a metal stud (total width 75 mm)</p> <p>100 mm block (low density 52 kg/m²) plastered/rendered 12 mm one side</p>
40–45		<p>1x12.5 mm plasterboard each side of a 48 mm metal stud with glass fibre/mineral wool in cavity (total width 75 mm)</p> <p>100 mm block (medium density 140 kg/m²) plastered/rendered 12 mm one side</p>
45–50		<p>2x12.5 mm plasterboard each side of a 70 mm metal stud (total width 122 mm)</p> <p>115 mm brickwork plastered/rendered 12 mm both sides</p> <p>100 mm block (medium density 140 kg/m²) plastered/rendered 12 mm both sides</p>
50–55		<p>2x12.5 mm plasterboard each side of a 150 mm metal stud with glass fibre/mineral wool in cavity (total width 198 mm)</p> <p>225 mm brickwork plastered/rendered 12 mm both sides</p> <p>215 mm block (high density 430 kg/m²) plastered/rendered 12 mm both sides</p>
55–60		<p>2x12.5 mm plasterboard each side of a staggered 60 mm metal stud with glass fibre/mineral wool in cavity (total width 178 mm)</p> <p>100 mm block (high density 200 kg/m²) with 12 mm plaster on one side and 1x12.5 mm plasterboard on metal frame with a 50 mm cavity filled with glass fibre/mineral wool on other side</p>

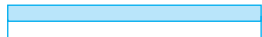
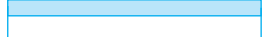
3 Sound insulation

Figure 3.10: Glazing - airborne sound insulation for some typical glazing constructions

Performance R_w (dB)		Glazing - typical forms of construction
25		4 mm single float (sealed)
28	 	6 mm single float (sealed) 4/12/4: 4 mm glass/12 mm air gap/4 mm glass
30	 	6/12/6: 6 mm glass/12 mm air gap/6 mm glass 10 mm single float (sealed)
33	 	12 mm single float (sealed) 16/12/8: 16 mm glass/12 mm air gap/8 mm glass
35	 	10 mm laminated single float (sealed) 4/12/10: 4 mm glass/12 mm air gap/10 mm glass
38	 	6/12/10: 6 mm glass/12 mm air gap/10 mm glass 12 mm laminated single float (sealed)
40	  	10/12/6 lam: 10 mm glass/12 mm air gap/6 mm laminated glass 19 mm laminated single float (sealed) 10/50/6: 10 mm glass/50 mm air gap/6 mm glass
43	 	10/100/6: 10 mm glass/100 mm air gap/6 mm glass 12 lam/12/10: 12 mm laminated glass/12 mm air gap/10 mm glass
45	 	6 lam/200/10: 6 mm laminated glass/200 mm air gap/10 mm + absorptive reveals 17 lam/12/10: 17 mm laminated glass/12 mm air gap/10 mm glass

7.5 (see also Figure 2.4) describes a purpose built music suite which uses buffer zones effectively. In some cases, such as the refurbishment of music facilities in existing buildings, room layout may not allow this, and in these cases high levels of sound insulation between adjacent rooms will be required.

3.12.5 Corridor walls and doors

The R_w values in Table 1.3 should be used to specify wall (including any glazing) and door constructions between corridors or stairwells and other spaces. To ensure that the door achieves its potential in terms of its airborne sound insulation, it must have good perimeter sealing, including the threshold where practical.

Note that a lightweight fire door will usually give lower sound insulation than a heavier, sealed acoustic door.

Greatly improved sound insulation will be obtained by having a lobby door arrangement between corridors or stairwells and other spaces. However, this is not often practicable between classrooms and corridors. Some noise transmission from corridors into classrooms is inevitable, but this may not be important if all lesson changes occur simultaneously.

For some types of room, such as music rooms, studios and halls for music and drama performance, lobby doors should generally be used.

3.13 Internal doors, glazing, windows and folding partitions

Internal doors, glazing and windows are normally the weakest part of any separating wall. Figures 3.10 and 3.11 show the performance of a number of different types of window and door. In general, rooms which require at least 35 dB $D_{nT}(T_{mf,max}),w$ should not have doors or single glazing in the separating wall or partition.

3.13.1 Doors

The choice of appropriate doors with good door seals is critical to maintaining effective sound reduction, and controlling the transfer of sound between spaces.

Internal doors are often of lightweight hollow core construction, providing only

around 15 dB R_w which is about 30 dB less than for a typical masonry wall (see Figure 3.5). The sound insulation of an existing door can be improved by increasing its mass (eg by adding two layers of 9 mm plywood or steel facings) as long as the frame and hinges can support the additional weight. However, it is often simpler to fit a new door.

The mass of a door is not the only variable that ensures good sound insulation. Good sealing around the frame is crucial. Air gaps should be minimised by providing continuous grounds to the frame which are fully sealed to the masonry opening. There should be a generous frame rebate and a proper edge seal all around the door leaf. Acoustic seals can eliminate gaps between the door and the door frame to ensure that the door achieves its potential in terms of its airborne sound insulation.

As a rule of thumb, even a good quality acoustically sealed door in a 55 dB R_w wall between two classrooms will reduce the R_w of the wall so that the $D_{nT}(T_{mf,max}),w$ is only 30-35 dB. Two such doors, separated by a door lobby, are necessary to maintain the sound insulation of the wall. Figure 3.12 shows the effect of different doors on the overall sound insulation of different types of wall. In a conventional layout with access to classrooms from a corridor, the corridor acts as a lobby between the two classroom doors.

3.13.2 Lobbies

The greater the distance between the lobby doors, the better the sound insulation, particularly at low frequencies. Maximum benefit from a lobby is associated with offset door openings as shown in Figure 3.13(a) and acoustically absorbent wall and/or ceiling finishes.

A lobby is useful between a performance space and a busy entrance hall. Where limitations of space preclude a lobby, a double door in a single wall will be more effective than a single door; this configuration is illustrated in Figure 3.13(b).

Inter-connecting doors between two music spaces should be avoided and a

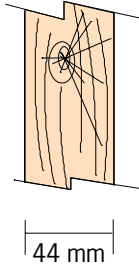
Acoustic performance**30 dB R_w** 

44 mm thick timber door, half hour fire rated

Typical construction

This acoustic performance can be achieved by a well fitted solid core doorset where the door is sealed effectively around its perimeter in a substantial frame with an effective stop. A 30 minute fire doorset (FD30) can be suitable.

Timber FD30 doors often have particle cores or laminated softwood cores with a mass per unit area $\approx 27 \text{ kg/m}^2$ and a thickness of $\approx 44 \text{ mm}$.

Frames for FD30 doors often have a 90 mm x 40 mm section with a stop of at least 15 mm.

Compression or wipe seals should be used around the door's perimeter along with a threshold seal beneath. A drop-down or wipe type threshold seal is suitable.

Doors incorporating 900 mm x 175 mm vision panels comprising 7 mm fire resistant glass can meet this acoustic performance.

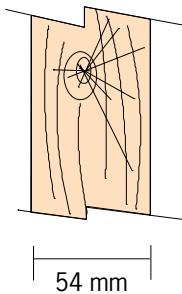
35 dB R_w 

54 mm thick timber door, one hour fire rated

This acoustic performance can be achieved by specialist doorsets although it can also be achieved by a well fitted FD60 fire doorset where the door is sealed effectively around its perimeter in a substantial frame with an effective stop.

Timber FD60 doors often have particle core or laminated softwood cores with a mass per unit area $\approx 29 \text{ kg/m}^2$ and a thickness of $\approx 54 \text{ mm}$. Using a core material with greater density than particle or laminated softwood can result in a door thickness of $\approx 44 \text{ mm}$.

Frames for FD60 doors can have a 90 mm x 40 mm section with stops of at least 15 mm.

Compression or wipe seals should be used around the door's perimeter along with a threshold seal beneath. A drop-down or wipe type threshold seal is suitable.

Doors incorporating 900 mm x 175 mm vision panels comprising 7 mm fire resistant glass can meet this performance.

NOTES ON FIGURE 3.11

- 1** Care should be taken to ensure that the force required to open doors used in schools is not excessive for children. To minimise opening forces, doors should be fitted correctly and good quality hinges and latches used. Door closers should be selected with care.
- 2** The opening force at the handles of doors used by children aged 5–12 should not exceed 45 N.
- 3** Manufacturers should be asked to provide test data to enable the specification of doorsets.
- 4** Gaps between door frames and the walls in which they are fixed should be $\leq 10 \text{ mm}$.
- 5** Gaps between door frames and the walls in which they are fixed should be filled to the full depth of the wall with ram-packed mineral wool and sealed on both sides of the wall with a non-hardening sealant.
- 6** Seals on doors should be regularly inspected and replaced when worn.

Figure 3.11: Doors - airborne sound insulation for some typical door constructions

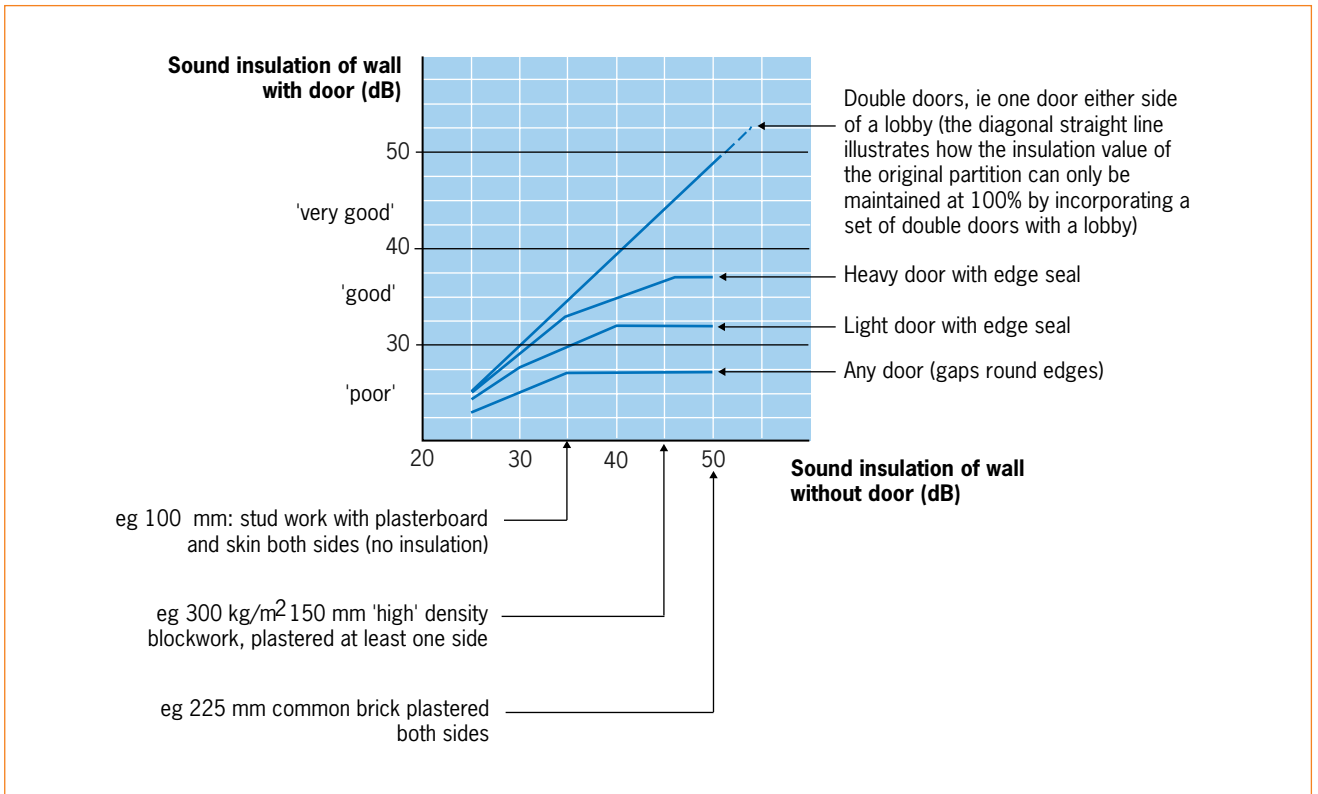

lobby used to provide the necessary airborne sound insulation.

3.13.3 Folding walls and operable partitions

Folding walls and operable partitions are sometimes used to provide flexibility in teaching spaces or to divide open plan areas. A standard folding partition with no acoustic seals or detailing may provide a value as low as 25 dB R_w . However, folding partitions are available that can provide up to 55 dB R_w . The sound insulation depends on effective acoustic sealing and deteriorates if seals or tracks are worn or damaged.

It is important that the specification of folding partitions takes into account their weight, ease of opening and maintenance. Regular inspection and servicing will extend the life of a partition and ensure that it achieves the required sound insulation.

Folding partitions are useful in many applications but they should only be used when necessary and not as a response to a non-specific desire for flexibility in layout of teaching areas.

3.13.4 Roller shutters

Roller shutters are sometimes used to separate kitchens from multi-purpose spaces used for dining. Because roller shutters typically only provide sound insulation of around 20 dB R_w it is common for noise from the kitchen to disturb the teaching activities. One

Figure 3.12: Reduction of sound insulation of a wall incorporating different types of door

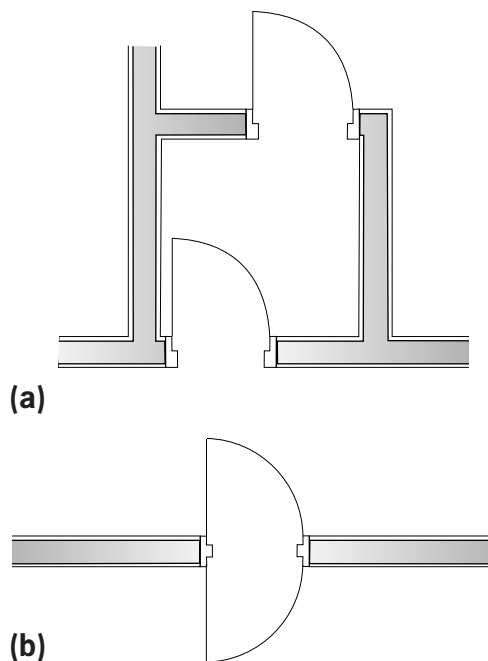

Figure 3.13: Use of lobbies and double doors
(a) Lobbyed doorway
(b) Double door

Figure 3.14: Existing timber floors - airborne and impact sound insulation for some typical floor/ceiling constructions

Option	Construction - timber floors	R_w (dB)	$L_{n,w}$ (dB)	Depth (mm)
1	Basic timber floor consisting of 15 mm floorboards on 150-200 mm wooden joists, plaster or plasterboard ceiling fixed to joists	35-40	80-85	180-230
2	As 1, ceiling consisting of one layer of 15 mm plasterboard and one layer of 12.5 mm dense plasterboard fixed to proprietary resilient bars on underside of joists	50-55	65-70	220-270
3	As 1, ceiling retained, with suspended ceiling consisting of 2 layers of 15 mm wallboard or 2 layers of 12.5 mm dense plasterboard, suspended on a proprietary metal ceiling system to give 240 mm cavity containing 80-100 mm mineral wool (>10 kg/m ³)	55-60	60-65	450-500
4	As 1, ceiling removed, with suspended ceiling consisting of 2 layers of 15 mm wallboard or 2 layers of 12.5 mm dense plasterboard, suspended on a proprietary metal ceiling system to give 275 mm cavity containing 80-100 mm mineral wool (>10 kg/m ³)	55-60	60-65	450-500
5	As 1, ceiling removed, with suspended ceiling consisting of 2 layers of 15 mm wallboard or 2 layers of 12.5 mm dense plasterboard, suspended special resilient hangers to give 275 mm cavity containing 80-100 mm mineral wool (>10 kg/m ³)	60-65	55-60	450-500
6	As 1 with proprietary lightweight floating floor using resilient pads or strips (eg 15 mm tongue-and-groove floorboards on a 15 mm plywood, chipboard or fibre-bond board supported on 45 mm softwood battens laid on 25 mm thick open-cell foam pads). 80-100 mm mineral wool (>10 kg/m ³) laid on top of existing floorboards	50-55	60-65	270-320
7	As 1, floorboards removed and replaced with 15 mm tongue-and-groove floorboards on a 15 mm plywood, chipboard or fibre-bond board supported on 12 mm softwood battens laid on 25 mm thick open-cell foam pads bonded to the joists, 80-100 mm mineral wool (>10 kg/m ³) laid on top of existing ceiling	55-60	55-60	240-290

Option	Construction - timber floors	R_w (dB)	$L_{n,w}$ (dB)	Depth (mm)
8	As 7 but mineral wool replaced by 100 mm pugging (80 kg/m ²) on lining laid on top of ceiling	55–60	50–55	240–290
9	As 8 but with 75 mm pugging laid on top of board fixed to sides of joists	50–55	55–60	240–290
10	As 1 with proprietary lightweight floating floor using a continuous layer (eg 15 mm tongue-and-groove floorboards on a 15 mm plywood, chipboard or fibre-bond board on 6-12 mm thick continuous open-cell foam mat)	50–55	55–60	220–270
11	As 10, ceiling removed and replaced with suspended ceiling consisting of 2 layers of 15 mm wallboard or 2 layers of 12.5 mm dense plasterboard, suspended on a proprietary metal ceiling system to give 275 mm cavity containing 80-100 mm mineral wool (>10 kg/m ³)	60–65	50–55	360–410

NOTES ON FIGURE 3.14

1 Where resilient floor materials are used, the material must be selected to provide the necessary sound insulation under the full range of loadings likely to be encountered in that room and must not become over-compressed, break down or suffer from long-term 'creep' under the higher loads likely to be encountered. Where large ranges of loading are encountered, or where there are high point loads such as pianos, heavy furniture or operable partitions, the pad stiffness may have to be varied across the floor to take account of these.

2 All figures are approximate guidelines and will vary between different products and constructions. Manufacturers' data should be obtained for all proprietary systems and constructions. These must be installed in accordance with good practice and manufacturers' recommendations and all gaps sealed.

Figure 3.14 Continued

solution is to provide doors in front of the shutters to improve the sound insulation.

3.14 Floors and ceilings

Both airborne and impact noise can be transmitted between vertically adjacent rooms through the separating floor and its associated flanking constructions.

Vertical noise transmission between classrooms can be a problem in older multi-storey buildings with wooden floors, such as traditional Victorian school

buildings. Both airborne noise and impact noise can be problematic with wooden floors, and both problems need to be considered when dealing with vertically adjacent spaces. Adding carpets or other soft coverings to wooden floors reduces impact noise but has very little effect on airborne noise transmission.

Impact noise can also be a problem with concrete floors (although airborne noise may not be a problem); this can sometimes be solved by adding a carpet.

Where the use of carpet is proposed

3

Sound insulation

Option	Construction - lightweight concrete floors	R_w (dB)	$L_{n,w}$ (dB)	Depth (mm)
1	Lightweight floor consisting of concrete planks (solid or hollow) or beam and blocks, with 30-50 mm screed, overall weight approximately 100 kg/m ² , no ceiling or floor covering	35-40	90-95	100-150
2	As 1 with soft floor covering >5 mm thick	35-40	75-85	105-155
3	As 1 with suspended ceiling consisting of 2 layers of 15 mm wallboard or 2 layers of 12.5 mm dense plasterboard, suspended on a proprietary metal ceiling system to give 240 mm cavity containing 80-100 mm lightweight mineral wool (>10 kg/m ³)	60-65	55-60	370-420
4	As 3 with soft floor covering >5 mm thick	60-65	50-55	375-425
5	As 1 with proprietary lightweight floating floor using resilient pads or strips (eg 15 mm tongue-and-groove floorboards on a 15 mm plywood, chipboard or fibre-bond board on 25 mm thick open-cell foam pads)	50-60	50-60	155-205
6	As 1 with proprietary lightweight floating floor using a continuous layer (eg 15 mm tongue-and-groove floorboards on a 15 mm plywood, chipboard or fibre-bond board on 6-12 mm thick continuous open-cell foam mat)	50-55	55-60	150-200
7	As 1 with heavyweight proprietary suspended sound insulating ceiling tile system	45-55	60-70	250-500

Figure 3.15: Lightweight concrete floors - airborne and impact sound insulation of some typical constructions

issues of cleaning, maintenance and effects on air quality may need to be considered.

3.14.1 Impact sound insulation

Impact noise on floors may arise from:

- foot traffic, particularly in corridors at break times/lesson changeover
- percussion rooms

- areas for dance or movement
- loading/unloading areas (eg in kitchens and workshops)
- machinery.

Where possible, impact noise should be reduced at source through use of soft floor coverings or floating floors. Carpets are not an option in practical spaces but other soft floor coverings, such as acoustic

Option	Construction - heavyweight concrete floors	R_w (dB)	$L_{n,w}$ (dB)	Depth (mm)
1	Solid concrete floor consisting of reinforced concrete with or without shuttering, concrete beams with infill blocks and screed, hollow or solid concrete planks with screed, of thickness and density to give a total mass of at least 365 kg/m^2 , with soft floor covering $>5 \text{ mm}$ thick	50–55	60–65	150–200
2	As 1 with proprietary lightweight floating floor using resilient pads or strips (eg 15 mm tongue-and-groove floorboards on a 15 mm plywood, chipboard or fibre-bond board on 25 mm thick open-cell foam pads)	55–60	50–55	200–250
3	As 1 with proprietary lightweight floating floor using a continuous layer (eg 15 mm tongue-and-groove floorboards on a 15 mm plywood, chipboard or fibre-bond board on 6-12 mm thick continuous open-cell foam mat)	55–60	50–60	175–230
4	As 1 with suspended ceiling consisting of 2 layers of 15 mm wallboard or 2 layers of 12.5 mm dense plasterboard, suspended on a proprietary metal ceiling system to give 240 mm cavity containing 80-100 mm mineral wool ($>10 \text{ kg/m}^3$)	60–70	55–60	420–470
5	As 4 with soft floor covering $>5 \text{ mm}$ thick	60–70	50–55	425–475

NOTES ON FIGURES 3.15 AND 3.16

1 Where soft floor covering is referred to this should be a resilient material or a material with a resilient base, with an overall uncompressed thickness of at least 4.5 mm ; or any floor covering with a weighted reduction in impact sound pressure level of not less than 17 dB when measured in accordance with BS EN ISO 140-8:1998^[15] and calculated in accordance with BS EN ISO 717-2:1997^[16].

2 Where resilient floor materials are used, the material must be selected to provide the necessary sound insulation under the full range of loadings likely to be encountered in that room and must not become over-compressed, break down or suffer from long-term 'creep' under the higher loads likely to be encountered. Where large ranges of loading are encountered, or where there are high point loads such as pianos, heavy furniture or operable partitions, the pad stiffness may have to be varied across the floor to take account of these.

3 All figures are approximate guidelines and will vary between different products and constructions. Manufacturers' data should be obtained for all proprietary systems and constructions. These must be installed in accordance with good practice and manufacturers' recommendations and all gaps sealed.

Figure 3.16: Heavyweight concrete floors - airborne and impact sound insulation of some typical constructions

vinyl floor or vinyl flooring laid on an acoustic mat, may be suitable.

Planning and room layout can be used to avoid impact noise sources on floors above noise-sensitive rooms. Soft floor coverings and floating floor constructions and independent ceilings are the most effective means of isolation, and resilient floor finishes are also appropriate for some sources.

Typical airborne and impact noise performance are listed for a number of constructions in Figures 3.14, 3.15 and 3.16. Note that, unlike airborne sound insulation, impact sound insulation is measured in terms of an absolute sound level, so that a lower figure indicates a better standard of insulation.

3.14.2 Voids above suspended ceilings

Where partitions run up to the underside of lightweight suspended ceilings, the airborne sound insulation will be limited by flanking transmission across the ceiling void, which will often prevent the minimum values for airborne sound insulation in Table 1.2 being achieved. Therefore, partitions should either be continued through the ceiling up to the soffit, or a plenum barrier should be used.

3.14.3 Upgrading existing wooden floors using suspended plasterboard ceilings

Figure 3.14 shows the airborne and impact noise performance of a standard wooden floor with various forms of suspended plasterboard ceiling.

Option 2 is possibly the most widely used system of increasing both impact and airborne sound insulation, with or without the original plaster ceiling. In small rooms good results can be achieved using timber studs fixed only to the walls, but large timber sections are needed to span wider rooms.

In wider span rooms it is generally more convenient to suspend the plasterboard from the floor joists above, fixing through the existing ceiling if this is retained, using a proprietary suspension and grid system (option 4). The grid can be hung from simple metal strips or, for higher

performance, special flexible ceiling hangers.

The major manufacturers of dry-lining systems all provide their own systems for these options, and provide sound insulation data and specifications for a variety of configurations. The performance for both airborne and impact sound improves with the depth of the ceiling void, with the mass of the ceiling and with the deflection of the ceiling hangers under the mass of the ceiling. Adding a layer of lightweight acoustically absorbent glass wool or mineral wool in the ceiling void increases the sound insulation, typically by 2-3 dB, but there is no point in adding more than specified.

Performance on site is strongly dependent on good workmanship to avoid air gaps, so careful attention should be given to ensuring that joints are close-butted, taped and filled and that all gaps are properly sealed. At the perimeter a small gap should be left between the plasterboard and the walls, and this should be sealed using non-setting mastic to allow a small amount of movement without cracking.

Penetrations through the ceiling need to be properly detailed to maintain an airtight seal while allowing movement, and services should not be allowed to provide a rigid link between the ceiling and the floor above. This can be a particular problem with sprinkler pipes. A problem with these constructions is that recessed light fittings, grilles and diffusers significantly reduce the sound insulation so any services should be surface-mounted.

A plasterboard finish is acoustically reflective whereas in some rooms an acoustically absorbent ceiling is required, to meet the specifications for room acoustics and reverberation times. One solution to this, if there is sufficient height, is to suspend a separate lightweight sound absorbing ceiling under the sound insulating plasterboard ceiling. This can be a standard lightweight composite or perforated metal tile system. These lightweight, acoustically absorbent, ceilings add very little to the sound insulation but do provide acoustic absorption. Lights and services can be recessed in the absorbent ceiling.

The term 'acoustic ceiling' generally refers to lightweight acoustically absorbent ceiling tile systems, designed to provide acoustic absorption. Note that these systems do not always increase the sound insulation as well.

There are, however, some systems which use relatively heavy ceiling tiles which are designed to fit into ceiling grids to provide a reasonably airtight fit. These may consist of dense plasterboard or mineral fibre products, or perforated metal tiles with metal or plasterboard backing plates. If properly installed and maintained these can provide a useful increase in sound insulation as well as acoustic absorption. Manufacturers of these systems can provide both airborne and impact sound insulation figures, as well as acoustic absorption coefficients. If no measured sound insulation data are provided, it is better to err on the side of caution and assume that the tile will not provide a significant increase in sound insulation.

The sound insulation performance figures quoted in Figure 3.14 all assume that the floorboards are in good condition and reasonably airtight, with thin carpet laid on top. If retaining the original floorboards it is good practice to fill in any gaps with glued wooden strips, caulking or mastic, or to lay hardboard on top, to provide an airtight seal. If not retaining the original boards, 18 mm tongue-and-grooved chipboard can be used to achieve the same effect, with all joints and gaps properly sealed, especially at the perimeters.

3.14.4 Upgrading existing wooden floors using platform and ribbed floors

The systems discussed in Section 3.14.3 all maintain the original wooden floor mounted directly on joists. This has the advantage of maintaining the original floor level at the expense of loss of ceiling height below. An alternative approach is to provide a floating floor system either on top of the existing floorboards (a platform floor) or to remove the existing floorboards and build a new floor on resilient material placed on top of the floor joists (a ribbed floor). In both cases

the increase in both airborne and sound insulation relies on the mechanical isolation of the floor from the joists using resilient material.

Figure 3.14 shows a number of typical lightweight floating floor constructions and indicative sound insulation figures. There are many proprietary systems using a wide range of isolating materials and manufacturers should supply test data in accordance with ISO 140 measurements.

The isolating layer will typically consist of rubber, neoprene, open-cell or closed-cell foams, mineral fibre or composite materials. The isolating layer can be in the form of individual pads, strips or a continuous layer of material.

The sound insulation increases with the deflection of the resilient layer (up to the limit of elasticity for the material), with the mass of the floating layer and with the depth of the cavity. Adding a layer of lightweight acoustically absorbent glass wool or mineral wool in the ceiling void increases the sound insulation, typically by 2-3 dB, but there is no point in adding more than specified. In each case the deflection of the material under the permanent 'dead' load of the floating layer and the varying 'live' loads of occupants and furniture must be considered. If the material is too resilient and the floating layer is insufficiently heavy or rigid, the floor will deflect under the varying loads as people move about the room. For this reason it is advantageous for the floating layer to be as heavy and as stiff as practicable, in some cases using ply or fibre-bond board (for mass) laid on top of the resilient layer, with tongue-and-grooved chipboard on top of this.

If there are likely to be very heavy local loads in the room (eg pianos) it may be necessary to increase the stiffness of the resilient material, or, in the case of pads, to space the pads more closely together to support these loads.

Junctions with walls and at doors need to be designed to maintain an effectively airtight seal while allowing movement of the floating layer. Manufacturers generally provide their own proprietary solutions for this, with or without skirtings.

Figure 3.17: Possible sound transmission paths and their prevention

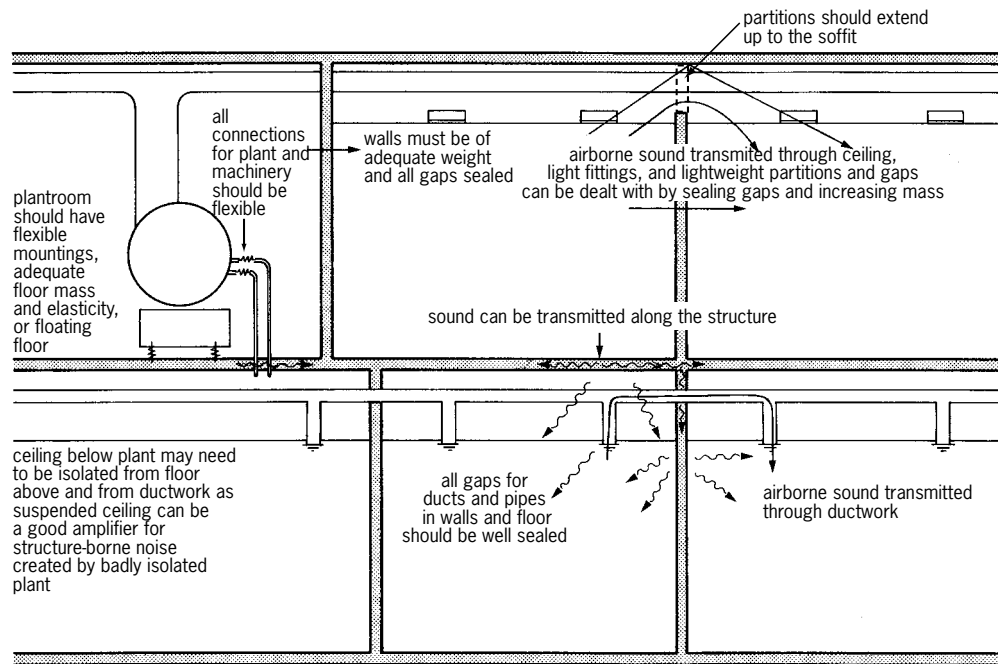

Lightweight floating floors are quite specialist constructions, and achieving the correct deflection under varying live loads without overloading the resilient material can be difficult. Most materials suffer from long term loss of elasticity or ‘creep’ under permanent loads and this should be taken into account in the design and selection of materials. The system manufacturer should normally be provided with all of the relevant information and required to specify a system to meet all of the acoustic and structural requirements over the expected lifetime of the floor. In difficult cases the advice of an acoustics consultant and/or structural engineer should be sought.

3.14.5 Concrete floors

In general, concrete floors provide much greater low frequency airborne sound insulation than wooden floors by virtue of their greater mass. There are, however, considerable variations in performance between dense poured concrete floors and comparatively lightweight precast concrete plank floors. Impact sound transmission can be a problem even in heavy concrete floors because of the lack of damping in concrete, and a soft or resilient floor covering is generally required. This may simply be carpet on suitable underlay.

Figures 3.15 and 3.16 show airborne

sound insulation and impact sound transmission data for a number of typical concrete floor constructions, with and without suspended ceilings and floating floors.

3.15 Design and detailing of building elements

Important points to remember when designing constructions to achieve adequate sound insulation are:

- Weak elements (eg doors and glazing, service penetrations, etc) will reduce the effectiveness of the walls in which they are located.
- Impact sound will travel with little reduction through a continuous member such as a steel beam or servicing pipe.
- Partitions between sensitive spaces should normally continue beyond the ceiling up to the structural soffit or roof layer, to prevent noise passing over the top of the partition above the ceiling or through a loft space.
- Openings in walls caused by essential services passing through should be acoustically sealed. Pipework passing between noise sensitive spaces should be appropriately boxed-in (see Approved Document E^[1]).

Figure 3.17 shows how possible transmission paths through the structure of a building can be prevented.

References

- [1] Approved Document E - Resistance to the passage of sound. The Stationery Office, 2003, ISBN 01 753 642 3
www.safety.odpm.gov.uk
- [2] Sound Control for Homes (BRE report 238, CIRIA report 127), 1993. Available from CRC Ltd. 1993, BRE ISBN 0 85125 559 0, CIRIA ISBN 0 86017 362 3, CIRIA ISBN 0305 408 X.
- [3] J McLoughlin, D J Saunders and R D Ford. Noise generated by simulated rainfall on profiled steel roof structures. Applied Acoustics 42 239-255, 1994
- [4] ISO 140-18 Acoustics - Measurement of sound insulation in buildings and of building elements - Part 18: Laboratory measurement of sound generated by rainfall on building elements (in preparation).
- [5] BS EN ISO 140-3: 1995 Measurement of sound insulation in buildings and of building elements. Part 3. Laboratory measurement of airborne sound insulation of building elements.
- [6] The Education (School Premises) Regulations 1999. (Statutory Instrument 1999 No 2, Education, England & Wales). The Stationery Office, 1999. ISBN 0 11 080331 0
www.hmsso.gov.uk
- [7] BS EN 20140-10: 1992 Acoustics - Measurement of sound insulation in buildings and of building elements. Part 10. Laboratory measurement of airborne sound insulation of small building elements.
- [8] BS 98/704582 DC. Ventilation for buildings. Performance testing of components/products for residential ventilation. Part 1. Externally and internally mounted air transfer devices. Draft for public comment (prEN 13141-1 Current Euronorm under approval).
- [9] BS EN 12354-3:2000 Building Acoustics - Estimation of acoustic performance in buildings from the performance of elements. Part 3. Airborne sound insulation against outdoor sound.
- [10] BS EN ISO 140-5: 1998 Measurement of sound insulation in buildings and of building elements. Part 5. Field measurements of airborne sound insulation of façade elements and facades.
- [11] BS EN 12354-1: 2000 Building Acoustics. Estimation of acoustic performance in building from the performance of elements. Part 1. Airborne sound insulation between rooms.
- [12] BS 476 Fire tests on building materials and structures.
- [13] BS EN ISO 140-6: 1998, Acoustics - Measurement of sound insulation in buildings and of building elements. Part 6. Laboratory measurement of impact sound insulation of floors.
- [14] BS EN 12354-2: 2000 Building Acoustics. Estimation of acoustic performance in building from the performance of elements. Part 2. Impact sound insulation between rooms.
- [15] BS EN ISO 140-8: 1998 Acoustics. Measurements of sound insulation in buildings and of building elements. Part 8. Laboratory measurements of the reduction of transmitted impact noise by floor coverings on a heavyweight standard floor.
- [16] BS EN ISO 717-2: 1997 Acoustics - Rating of sound insulation in buildings and of building elements. Part 2. Impact sound insulation.

The design of rooms for speech is a critical aspect of the acoustic design of a school. Rooms must be designed to facilitate clear communication of speech between teachers and students, and between students.

4.1 Approach to acoustic design

The vast majority of rooms in schools are designed for speech. A structured approach to the acoustic design of these rooms would consider the following subjects in the order given:

- 1 Indoor ambient noise levels (Table 1.1)
- 2 Room size - floor area, shape and volume and hence, required reverberation time (Table 1.5)
- 3 Amount of acoustic absorption required for reverberation time
- 4 Type, location, and distribution of that acoustic absorption
- 5 Special considerations for non-standard rooms (eg reflectors and diffusers)
- 6 Use of electronic sound reinforcement systems.

4.2 Internal ambient noise levels and speech clarity

The internal ambient noise level is very important in teaching spaces as the teacher's voice needs to be clearly heard above the background noise. The sound power output of conversational speech is typically 10 microwatts which results in a sound pressure level of about 60 dB at 1 m in front of the speaker. This output power can be raised to around 100 microwatts when the speaker talks as loudly as possible without straining the voice, which increases the sound pressure level at 1m to about 70 dB. By shouting, the output power can be further raised to around 1000 microwatts with a consequent further increase in sound pressure level to about 80 dB. In subjective terms, this means that a speaker can approximately double the loudness of the voice by speaking very loudly, and then double it again by shouting, see Figure 4.1.

It is also desirable to preserve the character, or nuances and intonations, of speech. This is particularly relevant to language teaching and to the performance of drama. The frequencies of sound in speech range from bass to treble, that is from below 125 Hz to above 8 kHz. Vowels have a sustained, tonal sound which contains characteristics of the speaker's voice. Men's voices have the lowest characteristic pitch (120 Hz), women an intermediate pitch (225 Hz), and children the highest pitch (265 Hz). Vowels contain most of the sound energy in speech but recognition of the consonants, whose energy is generally concentrated towards the higher frequency end of the speech spectrum, is the key factor for high intelligibility.

The intelligibility of speech depends upon its audibility as well as its clarity. Audibility is affected by the loudness of the speech relative to the background

Figure 4.1: Sound pressure levels of speech at 1 m

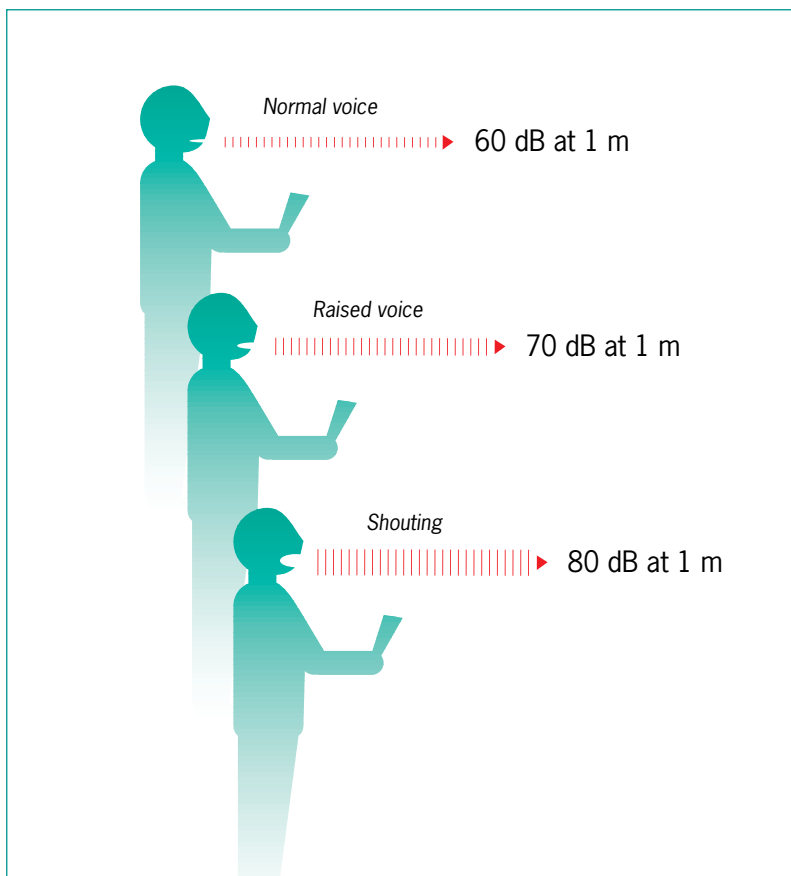

noise level. An increase in the background noise will cause greater masking of speech and hence will decrease intelligibility. It is possible to speak louder but this effect is limited and can also lead to voice strain. The indoor ambient noise levels for different rooms specified in Table 1.1 have been chosen to ensure that an adequate signal to noise ratio can be achieved without undue strain on the teacher's voice, and to minimise the effects of distraction from other sources.

4.3 Reverberation times

A classroom with a long reverberation time of several seconds will cause syllables to be prolonged so that they overlap and hence degrade speech intelligibility. Long reverberation times occur in large rooms with hard wall and ceiling surfaces. Adding acoustic absorption and reducing the ceiling height will reduce the reverberation time and will improve speech intelligibility. Table 1.5 specifies the reverberation times required for various teaching spaces ranging from teaching classrooms to assembly halls.

Appendix 2 describes the theory and terminology of reverberation time, acoustic absorption and enclosed volume. The methodology for calculation of reverberation time in rooms other than corridors, entrance halls and stairwells is described in Appendix 6, together with some worked examples. There is a link to a façade sound insulation and reverberation time computer spreadsheet for schools, from the DfES acoustics website.

Long reverberation times also increase reverberant noise levels within a room, which further decrease speech intelligibility. To compensate for this, in reverberant rooms people tend to increase their voice levels to make themselves heard over the reverberant noise, which further exacerbates the situation. This is a common feature of many school dining rooms and sports halls.

4.4 Amount of acoustic absorption required

The method described in Appendix 6 allows the amount and type of acoustic absorption to be calculated.

In general, in rooms for music performance, the reverberation time calculations will show that relatively little absorption is required in addition to that provided by the audience.

In classrooms and other rooms for speech, however, larger amounts of fixed acoustic absorption are often required, particularly where rooms have high ceilings as often occurs in older buildings.

When calculating reverberation times to comply with the specified values in Table 1.5 in rooms for speech, the absorption due to furnishings such as chairs, school desks and benches, may be ignored. Accurate absorption data for such items can be difficult to identify and if the furnishings have any effect it is likely to result in shorter, rather than longer, reverberation times.

4.5 Distribution of absorbent materials

The location of acoustic absorption within a room is important. The traditional calculation of reverberation time assumes that the absorbent surfaces in a room are reasonably evenly distributed. If this is not so, the reverberation time equation is not valid and undesirable local variations in the acoustics can occur, particularly in large rooms or halls. Large areas of acoustically reflective material can also lead to echoes, focusing and standing waves.

4.6 Room geometry

To achieve adequate loudness for all listeners in a room, it is necessary that the direct sound from speaker to listener has a clear unobstructed path. The loudness of the direct sound can be enhanced by strong, short delay reflections from room surfaces. These short delay reflections should arrive at the listener within one twentieth of a second (50 milliseconds) of the direct sound, which is approximately the time required for the ear to integrate such reflections with the direct sound. Strong reflections after 50 milliseconds tend to be detrimental to speech intelligibility, and ultimately, if the delay is long enough, they will be perceived as distinct echoes.

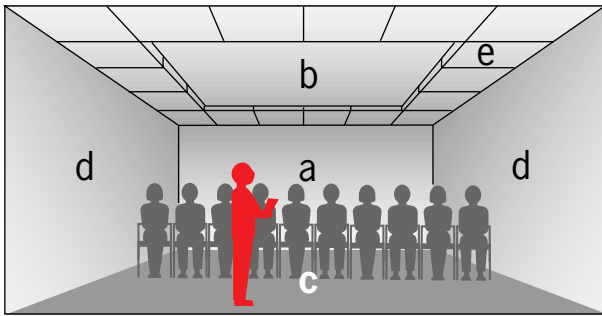

(a) Surface finishes in classroom or lecture theatre:
 a. Rear wall - sound absorbing or diffusing
 b. Ceiling - sound reflective (eg plasterboard)
 c. Floor - sound absorbing (eg carpet)
 d. Walls - sound reflective
 e. Ceiling - sound absorbing

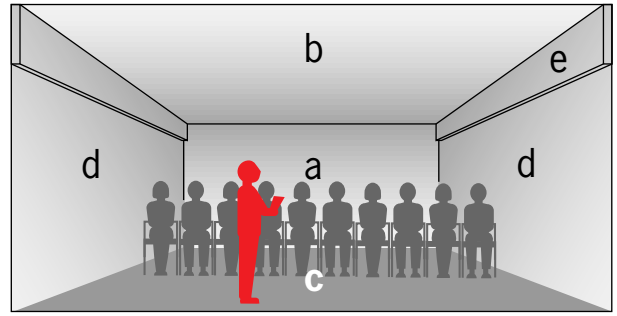

(b) Surface finishes in classroom or lecture theatre:
 a. Rear wall - sound absorbing or diffusing
 b. Ceiling - sound reflective (eg plasterboard)
 c. Floor - sound absorbing (eg carpet)
 d. Walls - sound reflective
 e. Top of walls - sound absorbing or diffusing

4.7 Classrooms

For classrooms and other rooms for speech, there are two approaches to locating the acoustic absorption:

1. To make the ceiling predominantly absorbent. In most cases a standard acoustically absorbent suspended ceiling will provide all of the necessary absorption. In the case of rooms with exposed concrete soffits (providing thermal mass to limit overheating in summertime) acoustically absorbent suspended baffles may be used. The ideal case is often to have the central part of the ceiling reflective with absorption at the edges, see Figure 4.2(a)

2. To leave the ceiling acoustically reflective (plaster, plasterboard, concrete, etc) and to add acoustic absorption to the walls. In these cases it is advisable to locate most of the absorption at high level and some on the back wall facing the teacher to prevent "slap echo" off the back wall. This is particularly important if the rear wall is concave or the distance from the speaker to the rear wall is greater than 8.5 m. see Figure 4.2(b).

In large rooms, reflections from the rear wall can be disturbing for a speaker if they arrive later than 50 milliseconds after the speech has been voiced. This can occur if the speaker to rear wall distance is greater than 8.5 m. To avoid this problem, the rear wall should be made acoustically absorbent, or acoustically diffusing.

There are instances where provision of sound field amplification can improve speech intelligibility, see Section 6.

4.8 Assembly halls, auditoria and lecture theatres

Most school halls are used primarily for speech functions such as assemblies, meetings and drama, and use for music is less frequent. The most common problem in school halls is excessive reverberation resulting in high noise levels and poor speech intelligibility.

4.8.1 Room geometry

The direct sound from speaker to listener must be as strong as possible at all positions. Because this sound weakens rapidly with distance according to the inverse square law (the intensity is reduced by a factor of four and the sound level falls by 6 dB when the speaker to receiver distance is doubled), the average distance between speaker and listener should be kept as small as possible. Furthermore, there should be no obstructions along the direct sound path.

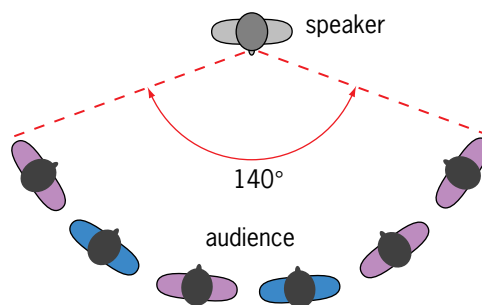
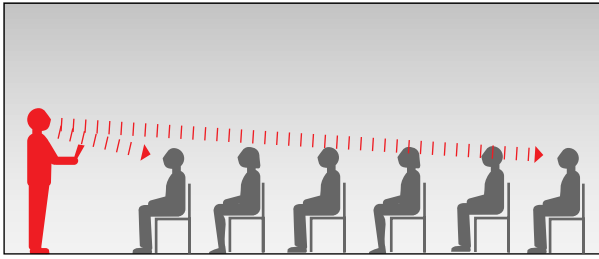

Figure 4.2: Surface finishes in classroom or lecture theatre

Figure 4.3: Ideal seating plan

4

The design of rooms for speech



(a) Adequate loudness is essential, direct sound must have a clear unobstructed path.

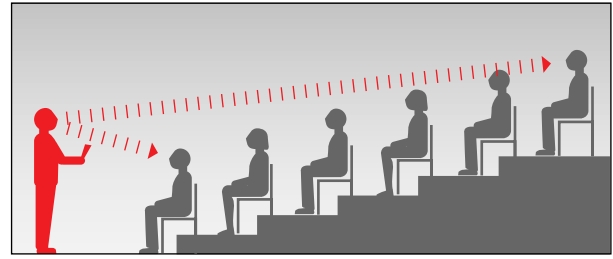

(b) Loudness of direct sound towards rear is increased with raked seating.

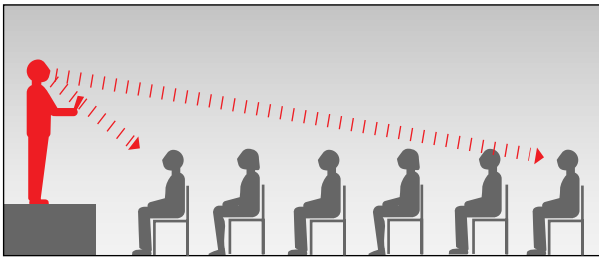

(c) Loudness of direct sound can be increased by putting the speaker on a platform.

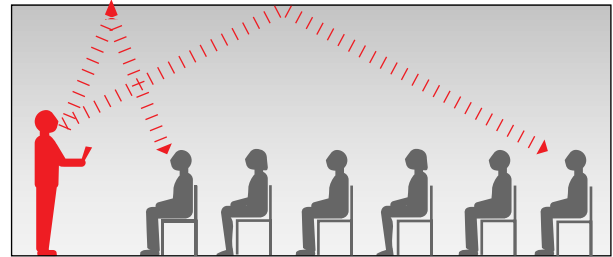

(d) Reflected sound enhances direct sound if time delay is less than 50 milliseconds.

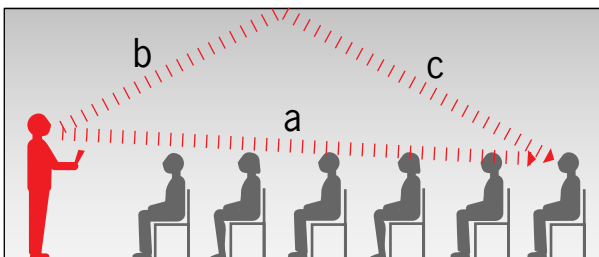

(e) For useful sound reflections, additional path travelled by reflected sound must be less than 17 m: $b+c - a < 17$ m.

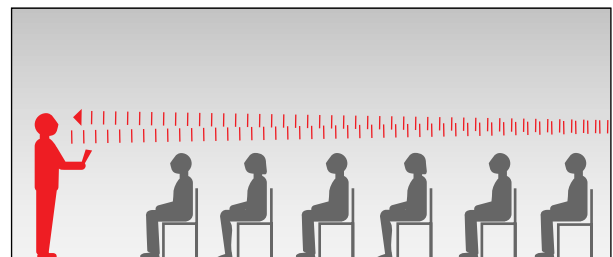

(f) Rear wall can cause a disturbing echo for speakers if over 8.5 m away. Rear wall should be absorbing or diffusing.

Figure 4.4: Effects of room geometry on speech.

For large rooms such as school halls, additional factors need to be considered in relation to the direct sound. First, the seating plan should be arranged to fall within an angle of about 140° subtended at the position of the speaker, see Figure 4.3. This is because speech is directional, and the power of the higher frequencies on which intelligibility largely depends falls off fairly rapidly outside this angle. Secondly, sound is weakened as it passes over seated people at grazing incidence. Therefore, if possible, listeners should be seated on a rake where a clearance of around 100 mm is provided between the sightline from one row and the sightline from the next, see Figures 4.4(a) and 4.4(b). It is known that if people can not

see the speaker well, they will not hear well either. It is frequently necessary in schools to have a flat floor in a school hall. In these cases, speakers should be raised on a platform which is sufficiently high to ensure that minimum clearance is obtained at the rear rows of the hall, see Figure 4.4(c).

The direct sound from speaker to listener can be enhanced by strong early reflections that arrive within 50 milliseconds, see Figure 4.4(d). These early reflections increase the loudness of the direct sound and therefore increase speech intelligibility. They are particularly useful at the furthest seats where the loudness of the direct sound has been reduced by distance. To provide

reflections within 50 milliseconds of the direct sound, hard surfaces must be located within a certain distance of the speaker and listener. In most rooms, the centre part of the ceiling is the most important reflecting surface and should be of hard, sound-reflecting material. Other useful surfaces providing early reflections are side walls near the speaker, overhead reflecting panels and angled ceiling panels.

The additional path travelled by the reflected sound should be no greater than 17 m more than the direct sound path between speaker and the seating area where the reflection arrives, see Figure 4.4(e).

Any reflection that arrives at a listener, or back at the speaker, more than 50 milliseconds after the direct sound is likely to be disturbing, see Figure 4.4(f). These are most probable in school halls where late reflections can occur from the rear wall or a control room window at the rear. Rear walls can be rendered sound absorbing or sound diffusing to avoid this. In the case of control room windows, these can be tilted to direct the reflection away from speakers and listeners.

Focusing of sound by domes or barrel vaults illustrated in Figure 4.5(a), can be a serious fault which can cause strong late reflections or echoes. If the dome or barrel vault is above a flat, hard floor as in a school hall, flutter echoes can occur which can be disturbing for speaker and listener alike. This effect can also occur with shallow pitched reflective roofs above a flat floor, see Figure 4.5(b) and the assembly hall in Case Study 7.1. The same effect can also occur on plan where a room has a curved or segmented rear wall opposite a flat front wall, see Figure 4.5(c).

4.8.2 Sound reinforcement

With an acoustically well designed room it is possible for strong speakers to achieve good speech intelligibility for large audiences. Quieter and untrained speakers, however, will not be able to do this and a speech reinforcement system is likely to be required for some functions.

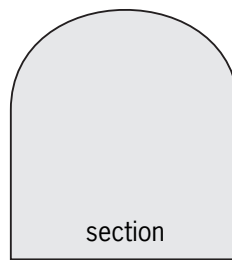

(a) Barrel vault can cause focusing and flutter echoes

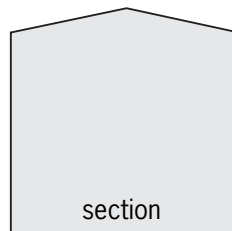

(b) Shallow hipped roof can cause focusing and flutter echoes

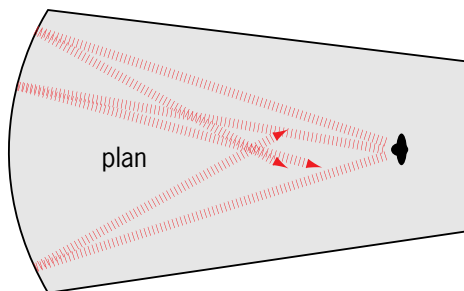

(c) Curved rear wall can cause focusing

Figure 4.5: Room shapes which can cause focusing and echoes

The key aim of such a system is to increase the loudness of the direct sound, particularly for more distant listeners, whilst keeping the sound as natural as possible.

The distribution of loudspeakers and their directional characteristics is a key issue in achieving high speech intelligibility. For large teaching rooms and lecture theatres, loudspeakers can be distributed in the ceiling or on the walls at high level. In school halls, column loudspeakers can be located on sidewalls, or in a central cluster as shown in Figure 4.6.

The design of sound reinforcement systems is a specialist field and specialist advice should be sought.

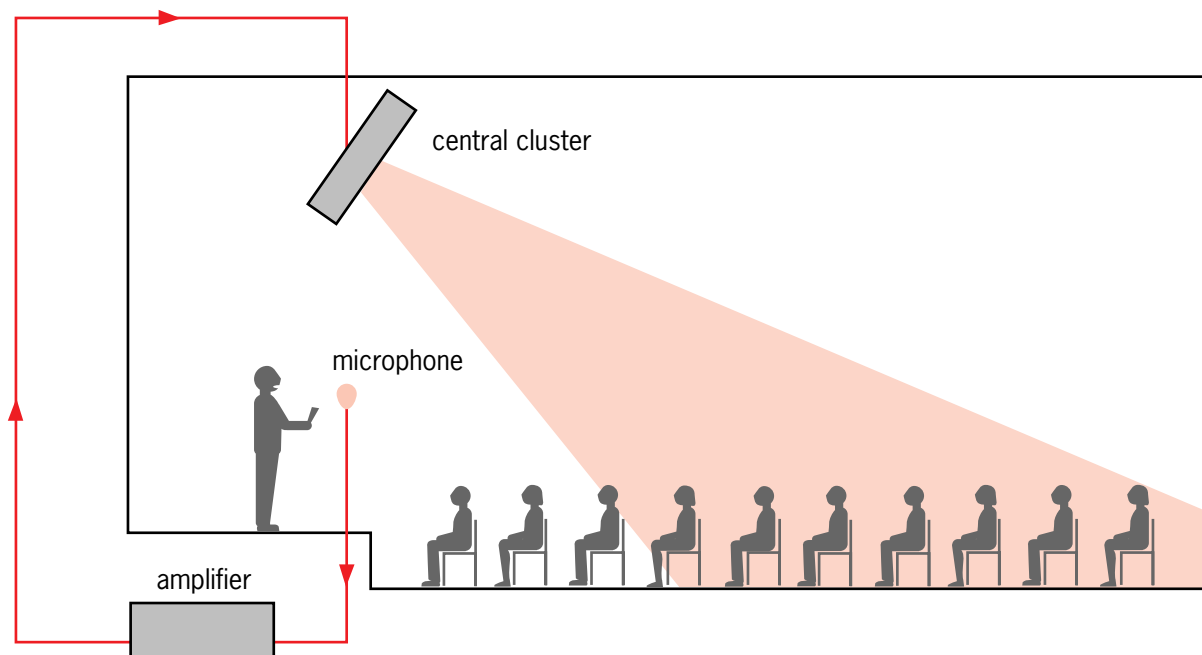

Figure 4.6: An arrangement of loudspeakers in a school hall

4.9 Open-plan teaching and learning areas

In open-plan areas it is essential to provide good speech intelligibility and to secure freedom from aural distraction by more distant sound sources and by background noise. Section 1 contains performance standards for speech intelligibility in open-plan spaces. Some degree of acoustic privacy is also desirable. This can be difficult to achieve in practice and there have been many instances of distraction and disturbance between class groups in open plan areas. Case Studies 7.2, 7.3 and 7.10 describe surveys of the acoustics of open-plan teaching areas in primary and secondary schools.

In open-plan areas, a carpeted floor is recommended together with a sound absorbing ceiling. In addition, sound absorbing screens should be interposed between class groups. Screens should be at least 1.7 m high and ideally should reach to within 0.5 m of the ceiling, see Figure 4.7.

A major improvement in the acoustic privacy between spaces in open-plan areas can be realised by installing full height moveable walls which, if fitted with seals, can provide a moderate degree of sound insulation between the divided spaces. In general however it is found that such screens are rarely used because of the time

and effort required to open and close them. While in theory it is possible to achieve adequate sound insulation between classrooms using high-performance moveable walls, there are issues of cost, weight, complexity of installation and maintenance to consider. Specialist advice from an independent consultant should always be sought if using such partitions to comply with the sound insulation requirements set out in Section 1 of this document.

Research has shown that in many large open-plan 'flexible' areas certain activities are severely restricted or have to be dropped because of noise interference. Indeed, it must be recognised that there are but a small number of activities that can share a degree of acoustic linkage and even then the timetable has to be designed to allow this.

Those plans which provide a generous range of spaces in a variety of sizes can be seen to give far more opportunities in teaching than those with large open spaces and moveable screens, because in the former it is possible to achieve good sound insulation standards between spaces.

When designing open-plan areas it is important to provide plenty of acoustically absorbent surfaces and to use screens to block direct sound paths.

4.10 Practical spaces

Spaces for teaching practical subjects have particular requirements which need careful design in order to comply with the acoustic requirements for teaching and learning. This section addresses the needs of Design and Technology spaces and Art rooms. Music rooms are considered separately in Section 5. Although Science involves a significant amount of practical activity, the general approach described for classrooms (Section 4.7) can be applied to spaces for the teaching of Science. For further information on Design and Technology spaces see Building Bulletin 81^[1] and the DfES acoustics website.

4.10.1 Design and Technology spaces

Design and Technology departments in secondary schools contain timetabled spaces for a variety of practical activities, eg graphics, resistant materials (wood, metal and plastics), electronics/control, food and textiles. They also include non-timetabled learning spaces, typically shared design/ ICT resource areas.

The equipment and the activities in these spaces can vary widely depending on the type and size of department. Activity noise and noise tolerance classifications for different spaces are given in Table 1.1. It is important to establish what activities will take place in any one space and what equipment will be used before calculating required levels of sound insulation to minimise the background noise in nearby spaces.

Resistant materials areas containing wood or metal working machinery can produce high noise levels. Machines extracting dust particles, CAD/CAM and other noisy equipment will increase the activity noise level of a space. It is important to consider the effects of such equipment on teaching activities both within the space containing the equipment and in adjoining rooms. Where possible, it is advisable to locate noisy equipment in spaces away from rooms housing quieter activities. CAD/CAM equipment is sometimes housed in a separate room or within purpose designed enclosures which can

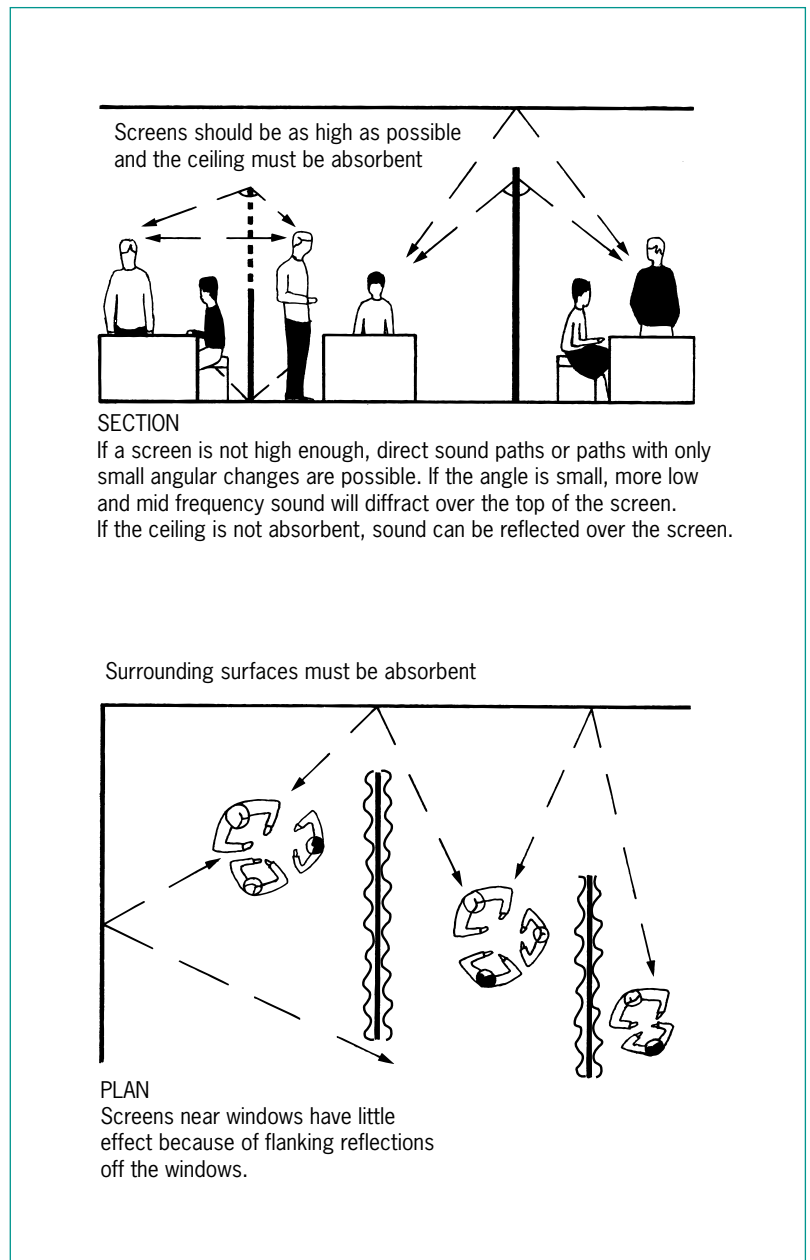

reduce the noise level.

The effect of noise from machines within the space is not required to be included in the indoor ambient noise level calculations submitted for approval by Building Control Bodies, except in the case of open plan arrangements. Often machines can be switched off when quieter learning activities such as group presentations are taking place, but this may not always be possible. The location and use of noisy equipment needs to be discussed and agreed with the user.

Partially glazed partitions have commonly been used between design and technology spaces, particularly between

Figure 4.7: Positioning of indoor screens

timetabled and non-timetabled spaces. This is both for ease of supervision and to emphasise the link between related design activities. However, these considerations must be balanced against the acoustic requirements. Large areas of glazing will both increase the reverberation time within a space and reduce the sound insulation of a partition. Both of these factors will have a detrimental effect upon the speech intelligibility within the space and other nearby spaces.

Similarly, if interconnecting doors are used between neighbouring rooms the doorsets must be chosen to provide adequate sound insulation.

Central resource areas are often located adjoining the circulation spaces of design and technology departments. A common arrangement uses the central resource area predominantly for individual and small group work but such areas are not generally suitable for whole class teaching. Usually, there are areas of glazing and doors between the central resource area and adjacent practical spaces. The central area should be suitable for most design/resource activities as long as the circulation is restricted to the department and does not include access to other parts of the school.

Where spaces are open plan or divided by moveable or extensively glazed partitions, it may be appropriate to adopt alternative acoustic performance standards in accordance with Section 1.2.1. This will need to be based on an activity plan for the area which has been agreed with the user.

The speech intelligibility in open plan spaces will need to be assessed using computer prediction models, as described in Section 1.1.7. This may apply to a shared design/ICT resource area where group presentation could take place at the same time as other activities.

4.10.2 Art rooms

Art classes in secondary schools involve independent and group activities which are in general quieter than those in other practical areas. Noise levels in secondary school art spaces are likely to be similar to those in a general classroom. However,

art departments tend to have a more informal environment reflecting the nature of the activity, and are often of open-plan design. There may be more glazing in partitions in art departments than in other parts of the school, to emphasise the importance of the visual environment.

4.10.3 Floor finishes in practical spaces

Carpets are not appropriate for most practical areas and so cannot be used as a way of increasing sound absorption or reducing the impact sound transmission through floors in science, art and design and technology spaces. They may however be suitable in some design/resource areas.

Acoustic vinyl flooring or a vinyl floor laid on top of an acoustic mat may be suitable for practical spaces where improved impact sound insulation is required. Resistance to indentation will need to be considered and a change of flooring may be necessary underneath fixed heavy machinery such as floor mounted machine tools.

4.11 Drama rooms

There are three types of drama room in common use:

- 1 Rooms for small scale drama teaching and practical work
- 2 Drama studios – for rehearsal, teaching and small-scale performance
- 3 Theatres and flexible spaces primarily for performance.

Rooms for small scale drama teaching and practical work are usually little more than classrooms, which may be fitted with curtains both for blackout and to reduce reverberation time. They may also be provided with a basic set of lights and dimmable main lighting.

Drama studios tend to be larger spaces dedicated to drama, with special equipment such as moveable staging, seating rostra, lighting and sound systems. They do not normally have fixed stages or platforms and the acoustics will tend to change with the layout, seating and audience. They may be fitted with heavy curtains on some or all walls, to allow some control of reverberation time, for

blackout, and to allow some flexibility in the room's appearance. In this case the wall finishes will generally be hard (masonry or plasterboard). Studios generally have wooden floors and acoustically absorbent ceilings, although large amounts of permanent lighting and rigging also provide useful diffusion.

Theatres and spaces primarily for performance vary considerably in form and size from the conventional assembly hall to adaptable theatres. They can be traditional theatres with fixed proscenium and stage, open stages, thrust stages or in the round, see Figure 4.8. Adaptable theatres can be converted from one arrangement to another depending on the type of performance.

Each type has different acoustic characteristics. The basic acoustic requirements for auditoria are discussed in Section 4.8, however spaces designed specifically for public performance are specialised rooms and the advice both of an acoustician and a theatre consultant should normally be sought.

For successful drama it is necessary for the audience to see and hear considerably better than in most school halls, because of the close relationship between actors and their audience. In principle, to achieve close communication between actor and the audience it is necessary to restrict the size of the auditorium so that the maximum distance from any member of the audience to the stage does not exceed 20 m. In small theatres this is not generally a problem, but for larger audiences it may require the use of balconies and galleries, giving rise to the traditional fan-shaped theatre (which is, however, very bad acoustically for music). Deep balconies are to be avoided as the space under these can be acoustically 'dead' and considerable care is required to ensure that reflections from the ceilings and walls compensate for the lack of direct sound in such areas.

It is common for theatres in schools to be used not only for drama, but also for lectures, films, meetings and music, which all have different acoustic requirements. The acoustics of multi-purpose halls are discussed in the following section.

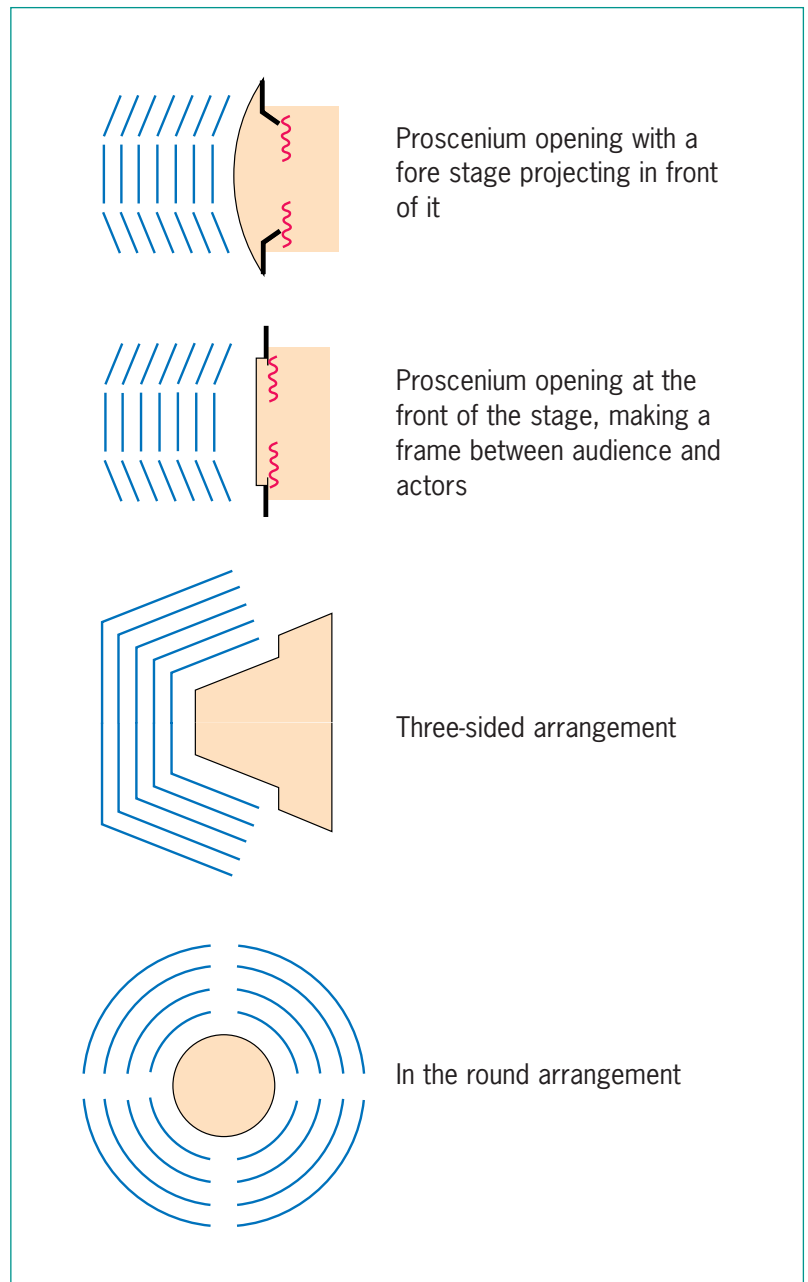

4.12 Multi-purpose halls

In large schools the multi-purpose space, intended to act as assembly hall, theatre, concert hall and gymnasium, is passing out of favour as it is difficult for a single hall to fulfil all of these functions well. None the less, in some cases a single flexible hall is required for a variety of uses and this gives rise to specific acoustic problems.

The different uses of multi-purpose halls often have conflicting acoustic requirements, making it difficult to provide a space with optimum acoustics for all uses. The main conflict is that between speech and unamplified music.

Figure 4.8: Typical performance spaces for drama

Speech	Music
"Dry" acoustic	"Live" or "warm" acoustic
Short reverberation time	Long reverberation time
Good clarity, loudness and intelligibility of speech	Even decay of sound
Sound must appear to come from stage with some contribution from room reflections but no perceptible reverberation	Good "envelopment" - audience should feel surrounded by the sound, and musicians should be able to hear themselves and each other easily
Small volume	Large volume

Table 4.1: General acoustic requirements for speech and music

Table 4.1 shows the general acoustic requirements for speech and music. (See also Section 5.7.)

Where regular performances of music are expected, reverberation time is sometimes changed using moveable areas of absorption (typically curtains) without changing the volume of the space.

Although this can successfully change the reverberation time at medium and high frequencies, it often has little effect at low frequencies, resulting in an acoustic which is less than ideal for either speech or music.

(Note that the 'dry' acoustic required for speech is also generally suitable for amplified music.)

Further information regarding the design of multi-purpose auditoria is given in Section 5.

4.13 Other large spaces

Sports halls, gymnasias and especially swimming pools have long reverberation times through the nature of their construction and surfaces necessary to their function. This results in high noise levels and poor speech intelligibility.

A variety of relatively rigid, robust and hygienic, acoustically absorbent materials are available and can be used. In general, these materials are installed on ceilings and at high level on walls or as hanging baffles. If there are large areas of acoustically hard parallel surfaces, flutter

echoes can occur, significantly increasing the reverberation time and reducing speech intelligibility. A reasonable distribution of acoustic absorption or diffusion (such as provided by wallbars against gymnasium walls) will eliminate this effect.

4.14 Dining areas

Dining areas suffer from excessive activity noise. The high activity noise interferes with conversation leading to increasing noise levels. Therefore, sound absorption is required in these areas to reduce the reverberant noise level. The most practical place to position sound absorption is on the ceiling and the walls. Shapes in section or on plan that produce focusing, such as barrel vaulted roofs and circular walls, should be avoided unless treated with sound absorbent material.

References

[1] Building Bulletin 81, Design and Technology Accommodation in Secondary schools, to be published January 2004 (replacing 1986 edition).

Music rooms require special attention in the acoustic design of a school. It is important to establish the user's expectations of the acoustic performance of the spaces. Musical activities range from playing, listening and composing in group rooms to orchestral performances in school halls, and a music room can be anything from a small practice room to a large room for rehearsing and performing music.

5.1 Aspects of acoustic design

Building Bulletin 86 Music Accommodation in Secondary Schools^[1] gives detailed design advice on the range of types of music spaces found in schools. The performance standards of the most common music room types are listed in the tables in Section 1.

Some non-specialist classrooms may be used for teaching music theory to large groups, with only occasional live or recorded music. In these rooms the majority of activity depends on good speech intelligibility rather than an enhanced acoustic for music and in these cases classrooms with the same acoustic criteria as normal classrooms may be used.

A brief, outlining the client's acoustic requirements, should be obtained before starting the design of any specialist music facility. The main problems are noise transfer between spaces, unsuitable reverberation times, flutter echoes, standing waves, and high noise levels.

5.2 Ambient noise

The requirements for indoor ambient noise levels in music rooms are set out in Table 1.1. To control noise from mechanical ventilation, it is important to select quiet fans or air handling units which are connected to appropriately sized silencers (attenuators). Typical primary attenuator lengths will be in the range 2.4 - 3.0 m. Air velocities in the duct system should be kept low and should not generally exceed 5 m/s in main ducts, 4.5 m/s in branch ducts and 2.5 m/s at runouts. Terminal units (grilles etc) should be selected for low noise output.

Noise from hot water radiator systems should be minimised by good design. Equipment, particularly the valves and pumps, should be designed and selected for quiet operation, with vibration isolation where appropriate.

In noise-sensitive spaces, such as music performance spaces and recording spaces, hot water pipes should not come into rigid contact with the building construction. Resilient pipe brackets and flexible penetration details should be adopted to prevent clicking noises resulting from expansion and contraction.

Lighting can cause disturbing buzzing and occasionally sharp cracks from expansion or contraction of metal fittings. In music rooms, 50 Hz fluorescent lights should not be used because they are inherently prone to buzzing and mains hum which is audible to some people. These effects do not occur with high frequency (HF) fittings, which should in general be specified on energy efficiency and cost saving grounds. HF fittings are acceptable for most general music spaces. Where the quietest conditions are required, lighting should be restricted to tungsten or similar lamps. In certain spaces such as a recording/control room, the sound caused by transformers used with low voltage spotlights can be distracting.

5.3 Sound insulation

Standards for sound insulation between different types of room are set out in Table 1.2. To avoid excessive noise transfer between music rooms Table 1.2 specifies a minimum of 55 dB $D_{nT}(T_{mf,max})_w$ between most music

rooms. These are minimum requirements and will not always prevent interference between adjacent rooms. It is beneficial to increase these figures, especially when the indoor ambient noise level is significantly below the level in Table 1.1. This can occur in naturally ventilated rooms on quiet sites where the indoor ambient noise level is too low to provide useful masking of distracting noise from adjacent rooms.

The level of sound and possible disturbance between music spaces will vary depending on the instruments being played. Clearly, as the loudness of the instruments varies from group to group, so the room-to-room sound insulation requirement will also vary. An important question is that of cost versus flexibility. High flexibility is desirable so that any instrument can occupy any room. However it is expensive to provide sound insulation to satisfy the most stringent requirement at all locations throughout the building. Alternatively, designating groups of rooms to groups of instruments severely limits flexibility but concentrates investment in sound insulation where it is most required.

Rooms for percussion and brass will generate high noise levels and great care is needed in choosing their location. Rooms for percussion should, if possible, be located at ground level to minimise the transmission of impact vibration into the building structure. Otherwise floating floor constructions may be required.

Figures 2.4 and 7.5.1 illustrate the principles of good planning, using corridors and storage areas as 'buffer zones' between music rooms where possible. This allows the sound insulation requirements to be met without resorting to very high performance constructions. However, in some cases such as refurbishments of existing buildings the provision of special sound insulating constructions, as discussed in Section 3, is the only option.

Background noise must be controlled in circulation areas. However, limited break-out of musical sounds into circulation routes is acceptable since it allows teachers to monitor, from a

distance, unsupervised small group musical activities.

5.3.1 Sound insulation between music rooms

The sound insulation required between the different types of music room can be determined from Tables 1.1 and 1.2.

Other criteria such as those of Miller^[2], which take account of both sound insulation and indoor ambient noise level, are sometimes used in the specification of sound insulation between music rooms; however, the normal way of satisfying Requirement E4 of The Building Regulations is to meet the performance standards in Table 1.2 for airborne sound insulation between rooms.

Case Study 7.5 gives an example of the acoustic design of a purpose built music suite in a secondary school.

5.4 Room acoustics

5.4.1 Reverberation time, loudness and room volume

In general, rooms for the performance of non-amplified music require longer reverberation times than rooms for speech. Figure 5.1 shows optimum mid frequency reverberation times for speech and music as a function of room volume.

The volume of a room has a direct effect on the reverberation time (RT) and early decay time; in general, the larger the volume, the longer the RT. The reverberation times should be in the ranges given in Table 1.5 and should be constant over the mid to high frequency range. An increase of up to 50% is permissible, and indeed is preferred, at low frequencies as indicated in Figure 5.2.

To achieve this it is generally necessary for the volume of music rooms to be greater than for normal classrooms and this generally requires higher ceilings. These also help with the distribution of room modes as described in the section on room geometry below.

If the volume of a room is too small, even with the correct reverberation time the sound will be very loud. This is a common problem in small practice rooms with insufficient acoustic absorption, and

can give rise to sound levels which could, in the long term, lead to hearing damage. Many professional orchestral musicians have noise-induced hearing loss due to extended exposure to high noise levels both from their own instruments and, to a lesser extent, from other instruments nearby. Under the Noise at Work Regulations 1989 (see Appendix 9) there is a general requirement to minimise noise exposure of employees in the school context, who for this purpose include full-time, part-time and freelance peripatetic music teachers. It is therefore important to ensure that practice, rehearsal and teaching rooms are neither excessively reverberant nor excessively small for a given occupancy.

Setting the floor area and ceiling height is normally the first step in designing a music room. The floor area is usually determined by the number of occupants and guidelines are given in Building Bulletin 86^[1], as are methods of curriculum analysis to determine the needs of a secondary school music department. A typical suite of music rooms in a secondary school might consist of:

Large performance/teaching room	85 m ²
Second teaching room	65 m ²
Ensemble room	20 m ²
Practice/group rooms	8 m ²
Control room for recording	10 m ²

Ceiling heights and consequently volumes for halls and recital rooms are generally equivalent to two storeys, around 6 m. For group rooms and practice rooms, a full storey height (at least 3 m) is normally required.

5.4.2 Distribution of acoustic absorption

The acoustically absorbent material required to achieve the correct RT should be distributed reasonably evenly about the room. Where absorption occurs only on the floor and ceiling – for example in a simple solution employing acoustic ceiling tiles and carpeted floor – users may experience an over-emphasis on sound reflections in a horizontal plane. This often leads to ‘flutter echoes’ between walls, which result in the actual

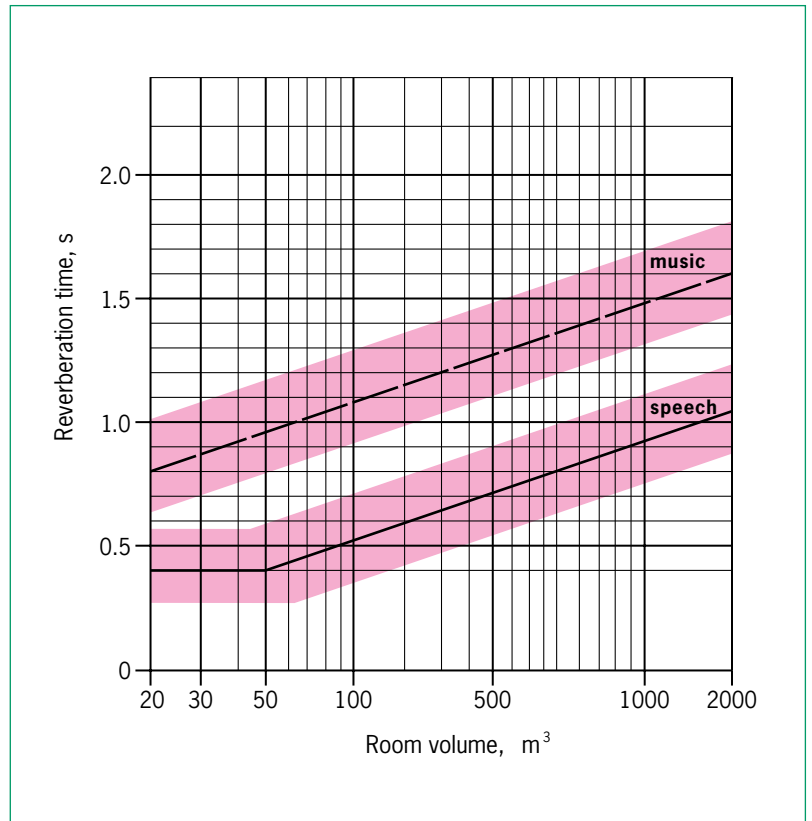
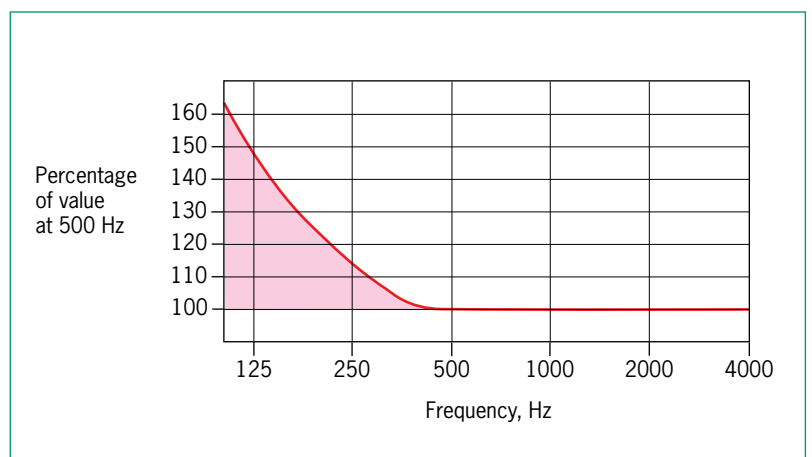

Figure 5.1: Optimum mid-frequency reverberation times for speech and music, for unoccupied spaces

RT being considerably longer than the calculated RT. A better solution, especially in large rooms, is to distribute some of the absorptive material about the walls.

Although the RT requirements in Table 1.5 are for unoccupied rooms, it is important to remember that the occupants will present a significant amount of absorption which will be in the lower half of the room. To give a reasonably even distribution of absorptive material therefore, acoustic absorption is

Figure 5.2: Recommended percentage increase in reverberation times at lower frequencies for rooms specifically for music



often located at high level on the walls.

Because of the absorption of the audience, there can be large variations in RT depending on the presence or absence of an audience. To reduce this effect, acoustically absorbent seats with upholstered backs can be used and in large halls the acoustic absorption of the seats has to be determined and specified quite carefully. An acceptable alternative in smaller halls can be the use of retractable curtains to reduce the RT during rehearsals when no audience is present.

In auditoria and music rooms, surfaces around and above the stage or performing area are normally reflective to provide feedback to the performers.

Floors on stage should be reflective although carpet in an auditorium may be permissible.

5.4.3 Room geometry

It is important to consider both room shape and proportion. In large rooms such as halls and recital rooms, the geometry of the room surfaces will determine the sequence of sound reflections arriving at the listener from a given sound source. Early reflections, that is those arriving within approximately 80 milliseconds of the direct sound, will be integrated by the listener's hearing system and will generally enhance the original sound for music (50 milliseconds is the corresponding figure for speech, see Section 4).

Prominent reflections with a longer delay (late reflections) may be perceived as disturbing echoes. This is often encountered where the rear wall in a hall has a large flat area of glass or masonry. Strong individual reflections can also lead

to 'image shifting' where early reflections can be so strong that the ear perceives the sound as coming from the reflecting surface and not the sound source.

This problem can be exacerbated if late reflections are particularly strong. This can occur when sound is focused from large concave surfaces such as curved rear walls, barrel vaults, domes, etc. Furthermore, focusing results in an uneven distribution of sound throughout the room. Consequently, large concave surfaces are not generally recommended in music spaces.

In small rooms, such as group rooms and music practice rooms, geometry affects the distribution of standing waves or room modes throughout the sound spectrum, particularly at low frequencies. Where the distance between two parallel walls coincides with or is a multiple of a particular wavelength of sound, a standing wave can be set up and the balance of sound will be affected, see Figure 5.3. Certain notes will be amplified more than the rest leading to an unbalanced tonal sound, sometimes called colouration. Bathrooms with tiled walls are a good example of rooms with prominent room modes and, although they can enhance certain notes of a singer's voice, they will not produce a balanced sound and will tend to sound boomy. The effect is exaggerated if distances are the same in more than one dimension. Thus rooms which are square, hexagonal or octagonal in plan should be avoided. The same effect occurs if the room width is the same as the room height, or is a simple multiple of it.

Ideally, the distribution and strength of room modes should be reasonably uniform. Perhaps the best way to control

Figure 5.3: Standing waves in different modes
0 – No sound pressure
1.0 – Maximum sound pressure

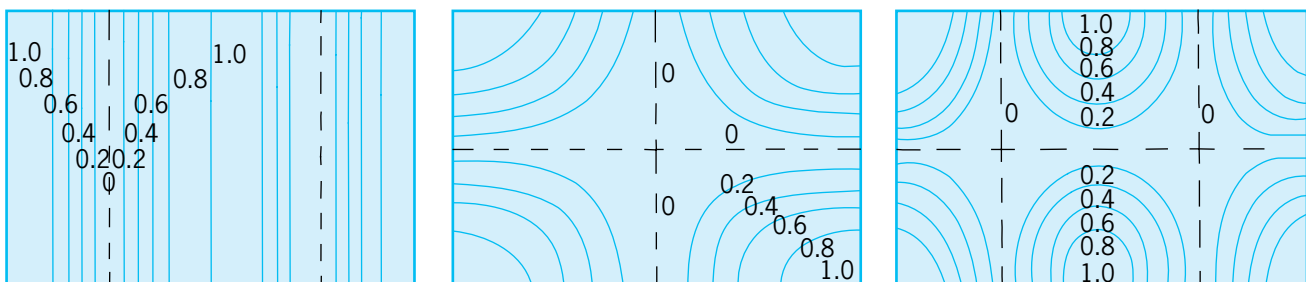

these low frequency modes is to select room dimensions that are not in simple ratios. It should not be possible to express any of the room dimensional ratios as whole numbers, for example, a proposed space 7 m wide, 10.5 m long and 3.5 m high (2:3:1) would not be considered an advisable shape from an acoustic point of view. Mathematically, an ideal ratio is 1.25 : 1 : 1.6; this is sometimes referred to as the ‘golden ratio’ but many other ratios work equally well.

Both flutter echoes and room modes can also be controlled by using non-parallel facing walls, but this is often impractical for architectural reasons; the use of absorption or diffusion is equally effective.

5.4.4 Diffusion

In addition to the correct RT, the room should be free from echoes, flutter echoes, and standing waves and the sound should be uniformly distributed throughout the room, both in the performance and listening areas. To achieve this without introducing too much absorption, it may be necessary to introduce diffusing hard surfaces to diffuse, or scatter, the sound. These are normally angled or convex curved surfaces but bookshelves, balcony fronts or other shapes can also provide diffusion, see Figure 5.4. Acoustic diffusion is a complex subject, and if calculation of diffusion is likely to be required a specialist should be consulted.

5.5 Types of room

5.5.1 Music classrooms

Figure 5.5 shows a 65 m² music classroom for a range of class-based activities involving a number of different instruments. The room proportion avoids an exact square. The height is assumed to be between 2.7 m and 3.5 m, creating a reasonable volume for the activities (see Section 5.4.3). The main points to note about the acoustic treatment of the space are described below.

To minimise the possibility of flutter echoes or standing waves occurring between opposing parallel walls, surfaces

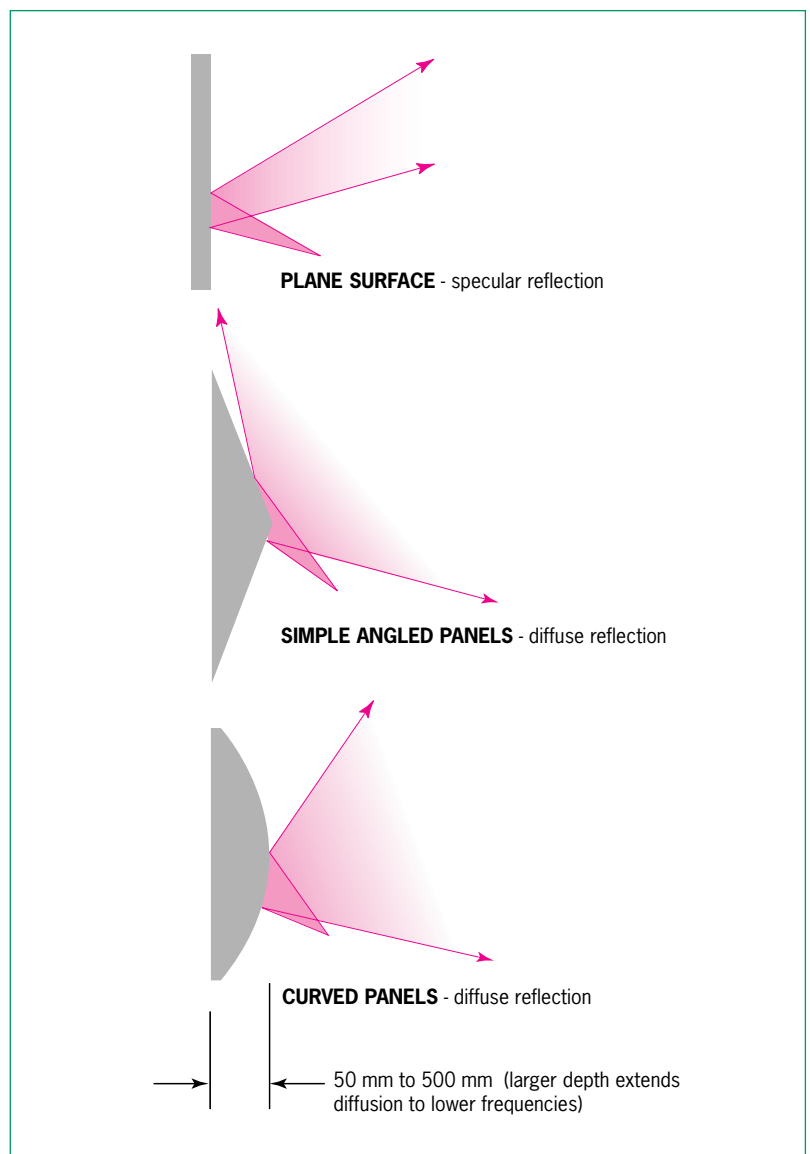

are modelled to promote sound diffusion. On the side wall this takes the form of shelving to store percussion instruments, etc. On the back wall, framed pinboards (with non-absorptive covering) are set at an angle, breaking up an otherwise plain surface.

Full length heavy drapes along the back wall can be drawn across to vary the acoustics of the space.

The observation window into the adjacent control room is detailed to ensure a high level of sound insulation between the two spaces (see Figure 5.6 and the discussion of control rooms below).

The door into the room is of solid core construction with a small vision panel. The door and frame details, Figures 5.7

Figure 5.4: Surfaces which provide specular and diffuse reflections

5 The design of rooms for music

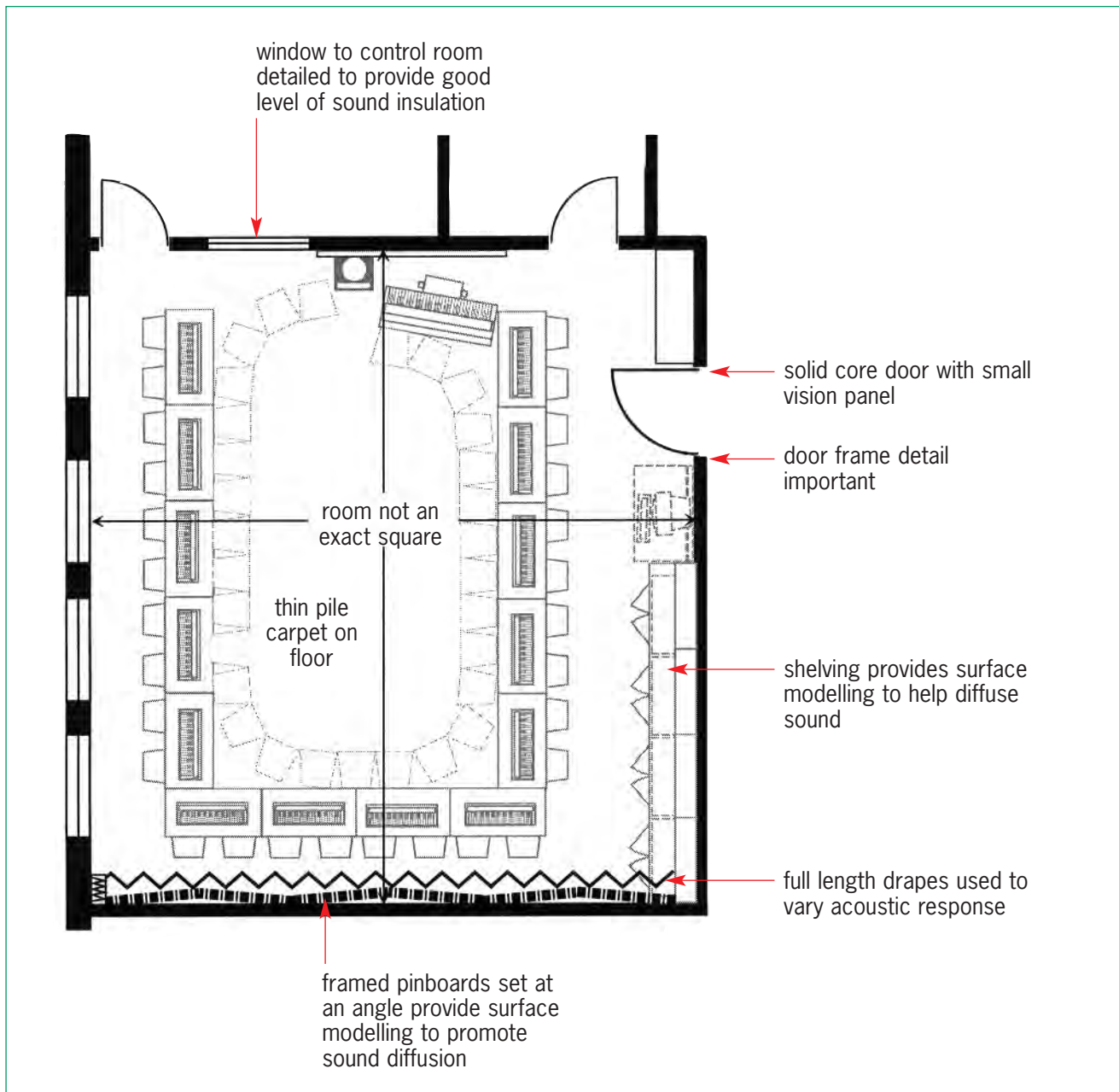

Figure 5.5: Acoustic treatment to music classroom

and 5.8, are designed to maximise the sound insulation properties of the wall as a whole.

The floor is fitted with a thin pile carpet providing an absorbent surface while the ceiling has a hard reflective surface. The type of carpet can have a significant effect on the overall RT in a room. It is worthwhile checking the precise absorption coefficient of any surface finish. (A spreadsheet of indicative absorption coefficients for common materials is on the DFES acoustics website.)

5.5.2 Music classroom/recital room

Figure 5.9 shows a larger, 85 m², classroom. The proportions of the room are in a ratio of fractional numbers (2.6 : 3.8 : 1) with the height between 2.7 m and 3.5 m as for the 65 m² music classroom. The acoustic treatment is similar to that for the 65 m² room but as this space is larger, and bigger groups are likely to rehearse and perform here, drapes are provided on two adjacent walls.

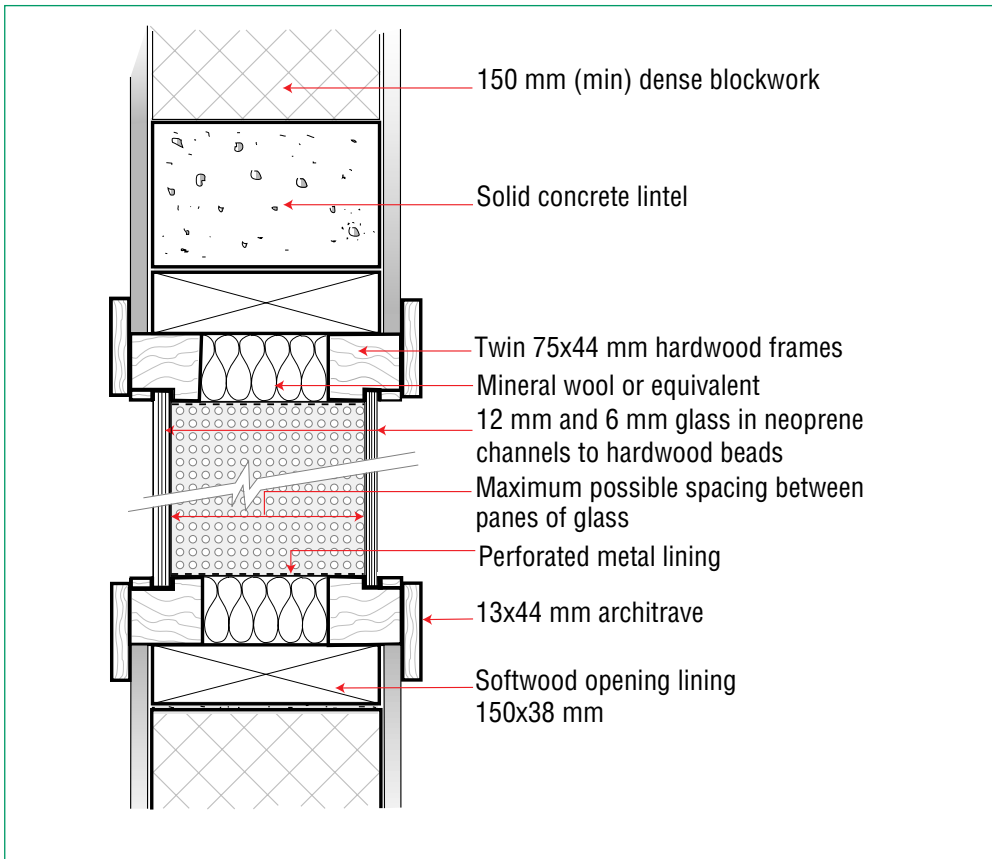

Figure 5.6: Section through control room window

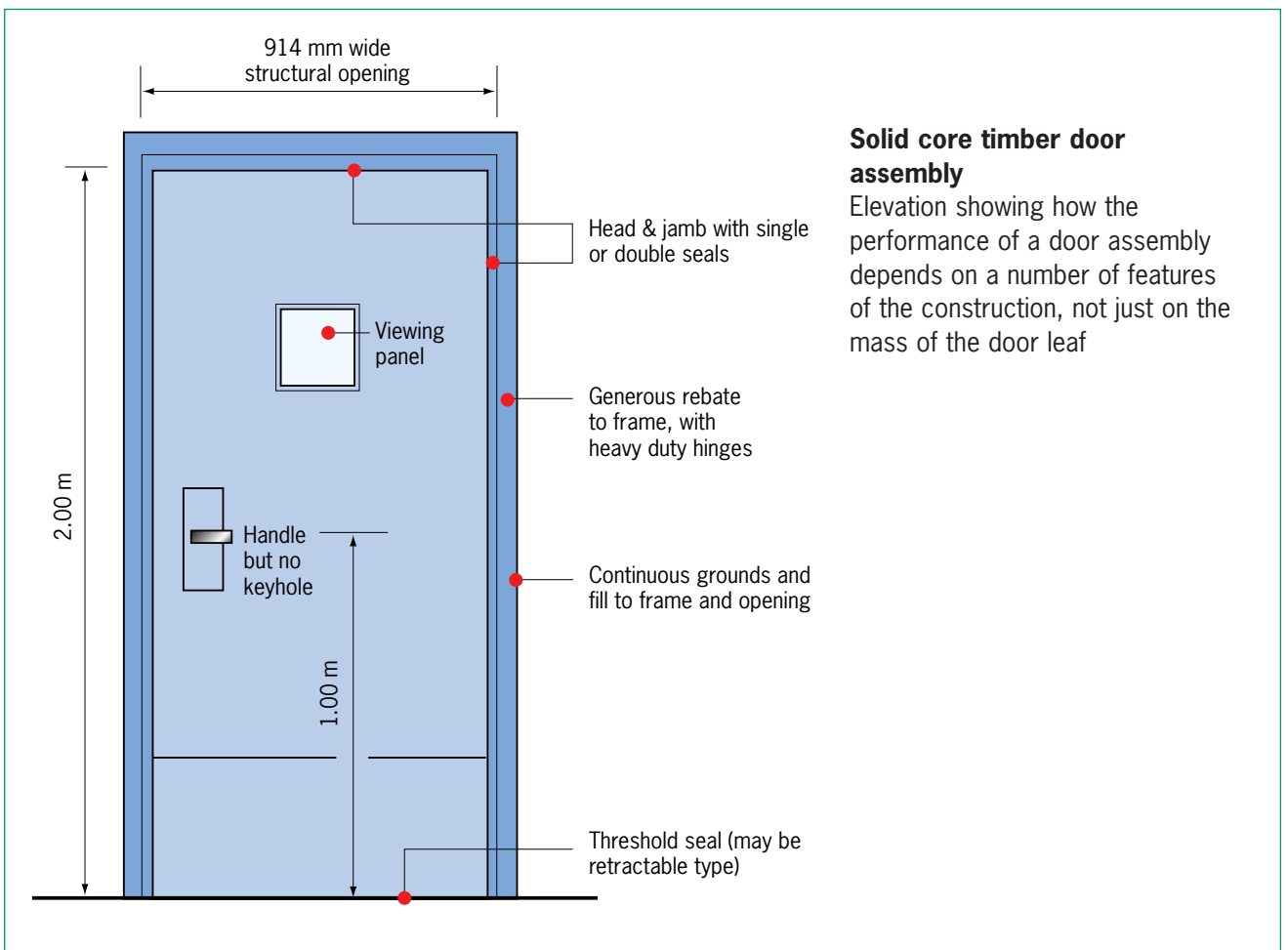
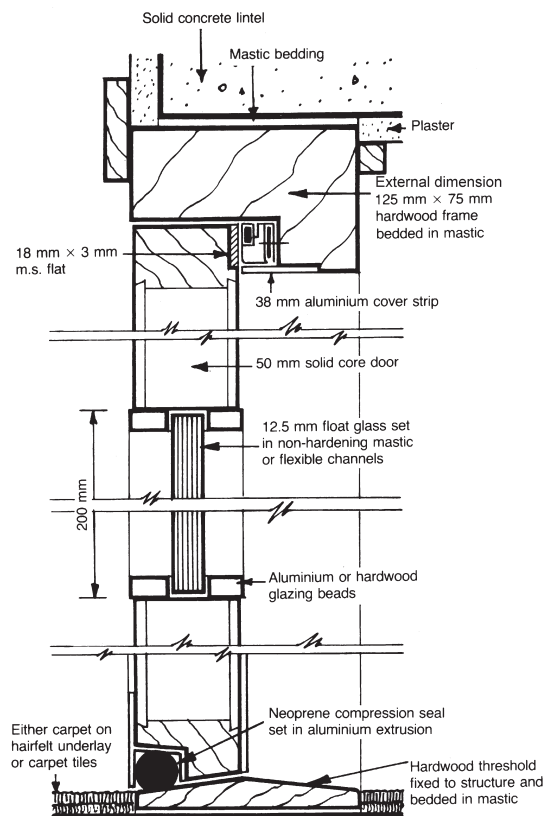

Figure 5.7: Desirable features of an acoustic door installation

Solid core timber door assembly

Elevation showing how the performance of a door assembly depends on a number of features of the construction, not just on the mass of the door leaf

VERTICAL SECTION



PLAN

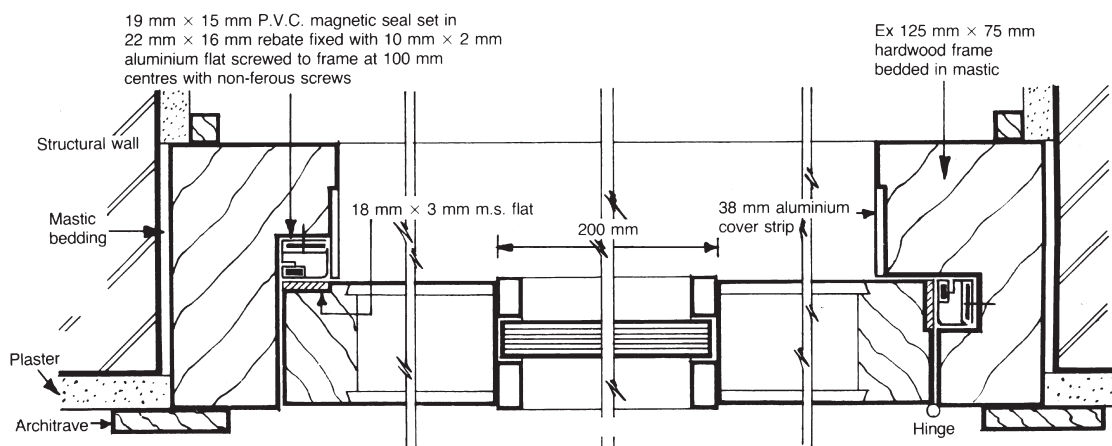

Figure 5.8: Vertical and horizontal sections through a door installation. Taken from BBC Engineering Guide to Acoustic Practice, 2nd Edition 1990. These drawings are reproduced here with the kind permission and co-operation of the BBC

5.5.3 Practice rooms / group rooms

Figure 5.10 shows a typical 8 m² group room which will accommodate both instrumental lessons and composition groups and which can be used for individual practice. Points to note are as follows.

- One wall is at an angle of 7° to avoid flutter echoes (a particular issue in small rooms) and prominent standing waves. Window and door reveals provide

useful diffusion to other walls.

- A full length drape can be pulled across the window to increase surface absorption and reduce loudness.
- The window is fairly small and positioned in the centre of the wall to control the amount of external noise reaching the space and avoid sound travelling between adjacent group rooms.
- Floor and ceiling finishes are as for the larger rooms.

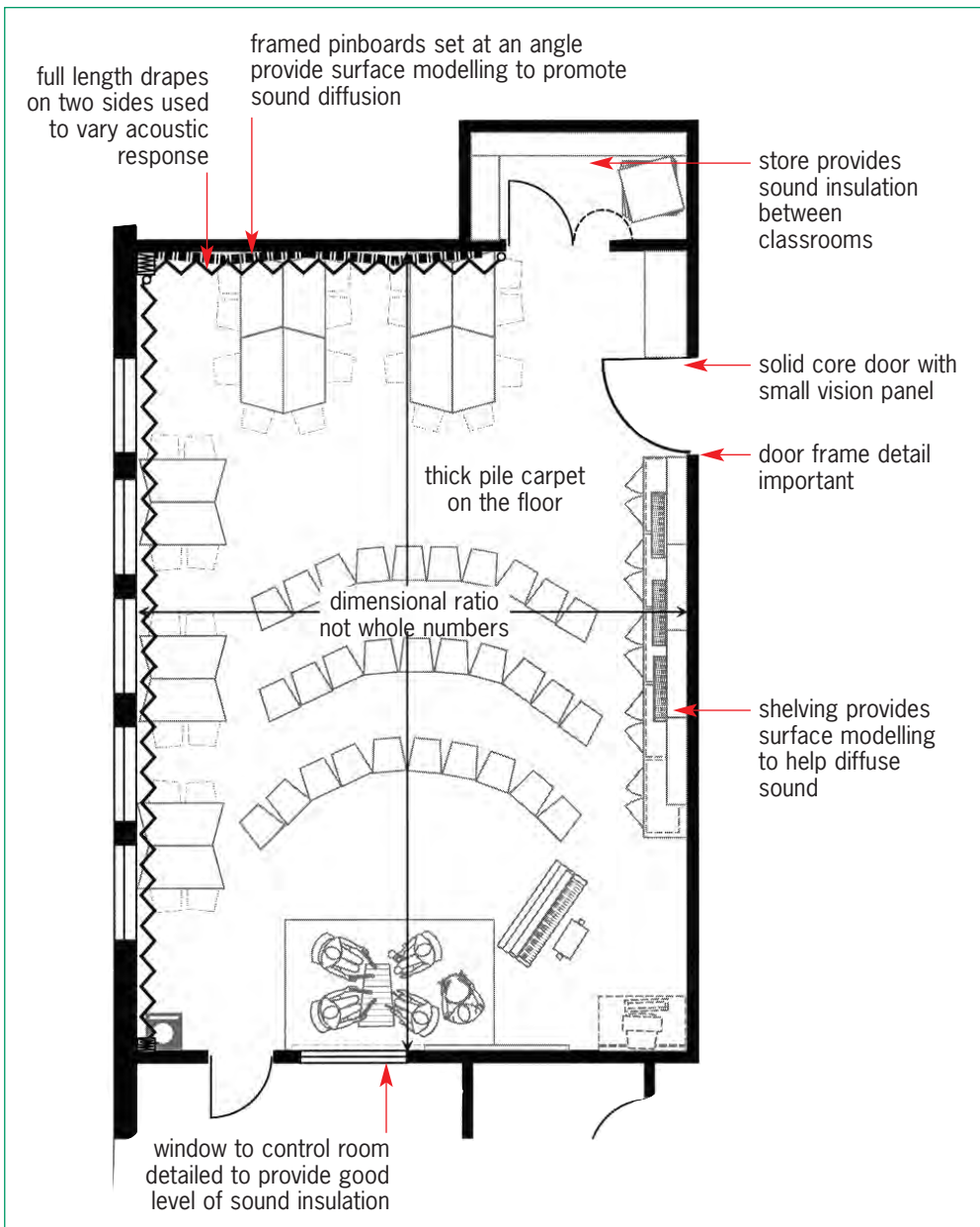

Figure 5.9: Acoustic treatment to music classroom/recital room

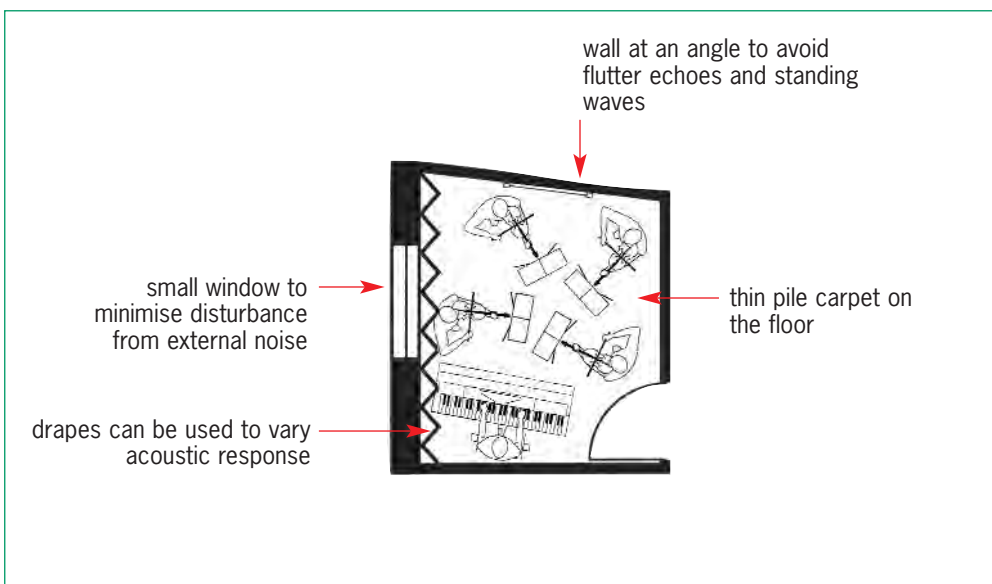

Figure 5.10: Acoustic treatment to 8 m² group room

5.5.4 Ensemble rooms

Figure 5.11 shows a plan of a 25 m² ensemble room. In terms of shape, the same rules apply as for larger music spaces. Ceilings should be high, of the order of 3 m or more. Surface finishes may comprise carpet on the floor, a suspended plasterboard ceiling to provide the necessary bass absorption, and a mixture of hard and soft wall finishes to provide the required RT. An acoustic drape along one wall can provide a degree of acoustic variability.

5.5.5 Control rooms for recording

Control rooms for recording have assumed a much greater significance due to the need to prepare tapes of compositions for GCSE assessment. Figure 5.12 shows an 11 m² control room for recording. A teacher or pupil can record a music performance taking place in an adjacent space after which the recording may be heard on headphones or loudspeakers. The RT specified in Table 1.5 is < 0.5 s.

Notable aspects of the acoustic treatment are as follows:

- Sound absorbing panels on the walls behind the monitor loudspeakers are used to control strong early sound reflections which could distort loudspeaker sound.
- Shelving units on the window wall provide surface diffusion.
- Drapes are fitted on all three observation windows. If a curtain is pulled across one window, problems of flutter echoes and prominent resonances associated with two facing hard parallel surfaces are reduced. Ideally, the effect can be avoided by installing glazing in one of each pair of windows at 5° off parallel. Drapes also provide additional privacy.
- The external window is small to minimise disturbance from external noise. A venetian blind can be used to control sunlight, or a blackout blind may be provided if required.
- The floor is carpeted.
- Figure 5.6 shows a detail of a typical

Figure 5.11: Acoustic treatment to 25 m² ensemble room

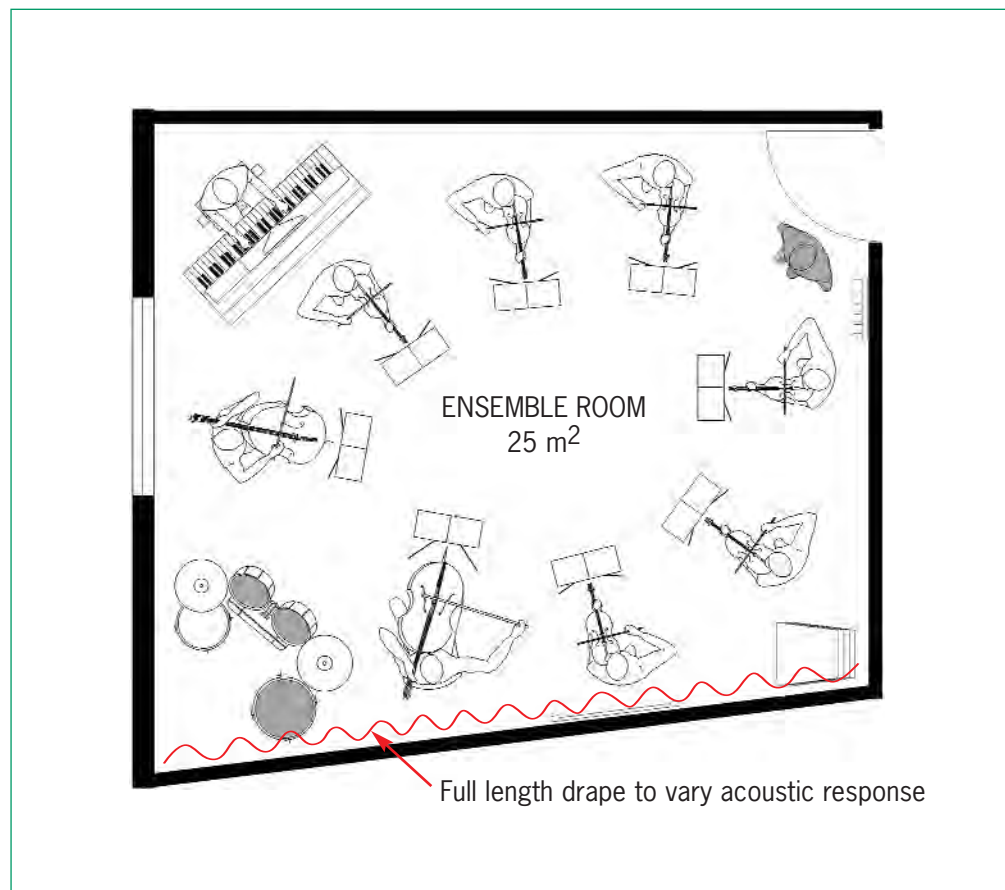

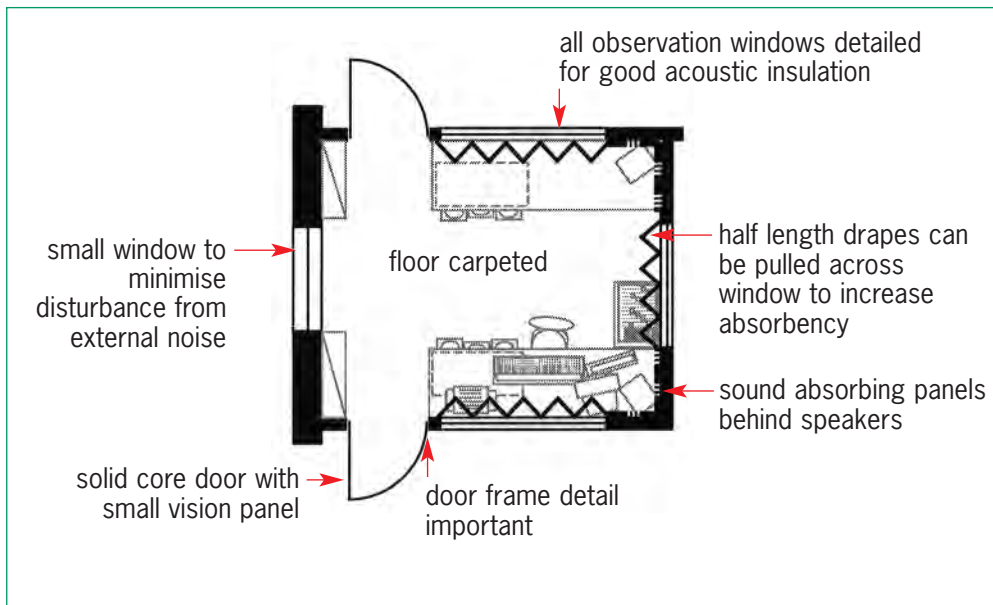

Figure 5.12: Acoustic treatment to recording/control room

control room window. Two panes of heavy plate glass (of different thicknesses to avoid the same resonances) are separated by an air gap of about 100-200 mm. Such a large gap may not always be possible but 50 mm should be considered a minimum. Each pane of glass is mounted into a separate frame to avoid a direct sound path. The glass is mounted in a neoprene gasket to isolate it from the wooden frame. Acoustically absorbent material, such as mineral wool or melamine foam, is incorporated into the reveal to absorb any energy that enters the air gap.

5.5.6 Recording studios

A recording studio as such rarely exists in a school. The control room for recording may have an observation window onto an ordinary ensemble room or professional/recital room. A professional type recording studio would require a lower indoor ambient noise level than that given in Table 1.1, and specialist advice should be sought.

5.5.7 Audio equipment

The design and selection of recording equipment and audio systems is a fast-evolving subject and guidance on specific technologies would be rapidly out of date. Although members of staff within a school will have their own preferences for specific items of equipment, these may be

based on experience of only a few systems and alternatives should at least be considered. Advice from an independent designer or consultant familiar with the full range of available equipment should be sought.

5.6 Acoustic design of large halls for music performance

Large halls designed primarily for music are rare in schools, where the main use of any large hall is likely to be for assemblies and other speech-related uses. Assembly halls, theatres and multi-purpose halls are discussed in Section 4. If a purpose-built concert hall is required a specialist acoustics designer should always be consulted early in the project, but this section sets out some general principles which can be considered at the concept stage.

5.6.1 Shape and size

Key acoustic requirements are sufficient volume to provide adequate reverberation and a shape that will provide a uniform sound field with strong reflections off the side walls. A rule of thumb is that the volume of a concert hall should be at least 8 m³ per member of audience, which is typically twice that for a theatre or cinema. In most cases this will lead to a rectangular floor plan with a relatively high ceiling. Other shapes, such as the elongated hexagon or asymmetrical

Figure 5.13:

Recommended balcony overhang proportions where the depth D should not exceed the height H .

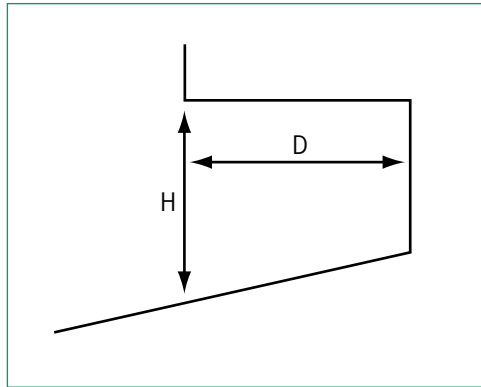

shapes, can work well but require very advanced acoustic design. Fan-shaped halls generally do not provide the lateral reflections beneficial to listening to music.

Balconies and side-wall boxes or galleries may be used although they tend to reduce the volume of the hall for a given audience size. Any overhangs must be kept small to allow reasonable sound to seats under the balcony. Figure 5.13 indicates the recommended proportions of an overhang so that good acoustic conditions are maintained beneath the overhang. Balcony, gallery and box fronts can be used to break up large areas of flat wall and provide essential diffusion, especially on parallel side walls where flutter echoes may otherwise occur.

Ceilings can be flat with some surface modelling, or can be more complex shapes to direct sound towards the audience. A steeply pitched ceiling (around 45° assuming the ridge runs along the length of the auditorium) can also be good. Shallow pitches can cause 'flutter' echoes between a flat floor and the ceiling, see Case Study 7.1.

Shapes with concave surfaces, such as domes and barrel vaults, cause focusing of sound which can result in problematic acoustics and these are best avoided. Where concave surfaces are unavoidable and cause a focus near the audience they should be treated with absorbent or diffusing finishes.

If seating is on a rake, this should not be too steep as musicians find it difficult performing into a highly absorbent audience block - in effect, they receive very little feedback. Generally, rakes

which provide adequate sightlines will give satisfactory acoustic conditions. This rake will generally be less than in a theatre or cinema.

The size and shape of the concert platform is of great importance. A full 90-piece symphony orchestra requires a stage at least 12×10 m, with allowance for choir risers behind. The front of the platform will not generally be as high as a theatre stage and may be only 400 mm above stalls floor level, but orchestral players will require risers or rostra so that players at the rear of the platform can see the conductor. Surfaces around the stage should be acoustically reflective and should be designed to provide some reflected sound back to the players, so that they can hear themselves and each other, as well as directing some sound towards the audience. This design requires computer or physical scale modelling by a specialist acoustician.

5.6.2 Surface Finishes

Unlike in theatres and assembly halls, the surface finishes in a concert hall with the correct volume will generally be acoustically reflective, for example plastered or fair-faced brick or blockwork. Large areas of flat lightweight panelling, such as wood or plasterboard, tend to be absorbent at low frequencies, which results in inadequate reverberation at these frequencies. The result tends to be a lack of 'warmth' or 'bass response' and is a common problem in many halls. Wood panelling, if used, must be very heavy or stiff. Curved wooden panels are often used as acoustic reflectors because their curvature gives added stiffness, reduces their inherent panel absorption and provides acoustic diffusion.

In most performance venues the seating and the audience provide the majority of the absorption and, therefore, constitute a controlling factor in the room acoustic conditions. The selection of seats and, particularly, the relative absorption of occupied and unoccupied seats is of great importance. In general, it is helpful if the room acoustics are relatively unaffected by the number of occupants. This, however, tends to mean

that seating must be very absorptive and probably not a preferred type for school use. A seat which is moderately upholstered on the seat and back is likely to be a good compromise. Where tip-up seats are provided they should be upholstered underneath as well as on the seat; otherwise acoustic conditions will be very different during rehearsal and performance. Most auditorium seating manufacturers supply acoustic test data. Where there is no fixed seating, large areas of acoustic drapes or other operable acoustic absorption can be used to reduce reverberation in rehearsal conditions when the seats are removed.

5.7 Design of large auditoria for music and speech

Table 5.1 lists the general acoustic characteristics that are required for a multi-purpose auditorium.

There are four commonly considered approaches to designing these spaces:

1. To design a concert hall with a large volume ($\approx 10 \text{ m}^3$ per seat), and to reduce the volume of the auditorium when needed for speech. This approach is recommended when the overwhelming requirement is for a good musical acoustic, with a relatively small proportion

of theatre or other speech use. Unless the volume can be reduced substantially, this approach requires large amounts of absorbent material to be deployed, which in turn can reduce loudness to the extent at which a speech reinforcement system is needed. Nearly all auditoria adopting this approach depend on high-quality speech reinforcement systems, which are difficult to design in a reverberant hall.

2. To design a small volume (not more than 6 m^3 per seat) with acoustics suitable for a theatre, with additional reverberant volumes accessed by openable flaps or moveable ceilings. As the volume needs to be increased by up to 80%, with reasonably even distribution of absorption, this is often impracticable. In the few cases where this approach has been tried, the results have been poor because it is difficult to provide openings large enough to be transparent to the long wavelengths of low frequency sound.

3. To design to a compromise volume and RT, often with curtains or other moveable acoustic material to provide some variation in RT. The result tends to be an auditorium which is acceptable for a range of uses, but not particularly good for any of them - especially music. Very large areas

Table 5.1: Acoustic characteristics for a multi-purpose auditorium

Low ambient noise levels	Low noise levels from plant, ventilation, lighting and stage machinery are required. Noise from outside the auditorium should ideally be imperceptible.
Even distribution of sound	The acoustic should not change significantly from one seat to another.
Lack of acoustic defects	There should be no echoes or focusing effects.
Loudness or acoustic efficiency	The sound level reaching the listener should be as high as possible without compromising other requirements.
Good direct sound	The sightlines to the source should not be impeded and distances should be as short as possible.
Good early reflections	Reflecting surfaces around and close to the stage, and reflections off the side walls and off the ceiling are required.
Feedback to performers	Some sound from the stage should be reflected back to the source. This gives confidence to the performers and helps with musical ensemble.

of curtain are required to have any significant effect in a large hall, and these will have relatively little effect at low frequencies, resulting in a room that is either ‘boomy’ for speech or ‘dead’ for music.

4. To design a small volume ($\approx 6 \text{ m}^3$ per seat) with acoustics suitable for a theatre, with an electro-acoustic enhancement system to introduce more reflected sound. These systems were originally designed to enhance the acoustics of naturally poor auditoria, but their success has recently led to their being built in to new auditoria where a wide range of acoustic conditions is required. The best systems provide good acoustics over a wider range of uses than would otherwise be possible, without the audience (or musicians) being aware that the sound that they hear is not due to the ‘real’ acoustic of the auditorium. These systems are seen as acoustically very advanced and are not commonly used in schools, but present a viable option where a large hall is to be used for both speech and music on a regular basis. These systems require loudspeakers in the auditorium side walls and ceilings, and should not be confused with the sound reinforcement system for speech (in this case a central cluster of loudspeakers over the forestage), although some electro-acoustic enhancement systems can also be used for speech reinforcement.

References

- [1] Building Bulletin 86, Music Accommodation in Secondary Schools. DfEE, 1977. ISBN 0 11 271002 6.
- [2] J Miller, Design standards for the sound insulation of music practice rooms. Acoustics Bulletin 18(6), Institute of Acoustics, 1993.

When considering classroom acoustics, children with a permanent hearing impairment have traditionally been treated as a special group, separate from the mainstream school population. This is a situation that is not supported by the surveys of the school population carried out by the British Association of Teachers of the Deaf.

6.1 Children with listening difficulties

A recent survey by the British Association of Teachers of the Deaf (BATOD)^[1] showed that about 75% of deaf children were being educated within mainstream schools. With the continuing trend towards inclusive education there is no reason to suppose that this proportion should do anything but increase.

In addition to the children with permanent hearing impairments there are large numbers of children within mainstream schools who have listening difficulties placing them in need of favourable acoustic conditions. These include children:

- with speech and language difficulties
- whose first language is not English
- with visual impairments
- with fluctuating conductive deafness
- with attention deficit hyperactivity disorders (ADHD)
- with central auditory processing difficulties.

Effort given to addressing the acoustic needs of the hearing impaired population also favours other groups whose needs for good acoustic conditions are not dealt with elsewhere in this document. Put together, the number of children falling into one or more of these categories could conceivably be a significant proportion within every mainstream classroom.

6.2 Children with hearing impairments and the acoustic environment

The majority of children with hearing impairments use speech and hearing as their main form of communication. The BATOD survey^[1] indicated that 67% of children with hearing impairments were using an auditory-oral approach and a

further 26% used an approach which combined sign with auditory-oral components. For these groups a poor acoustic environment can be a significant barrier to inclusion.

A hearing loss is typically described with reference to the audiogram. This is a graphical representation of an individual's threshold of hearing for a number of pure tones (typically measured at 250 Hz, 500 Hz, 1 kHz, 2 kHz, 4 kHz and 8 kHz) and presented to each ear using headphones. At face value, it suggests that the hearing impairment can be considered as a simple auditory filter and as such should predict a child's understanding of speech using traditional acoustic models. Although reliable, it says little about an individual's hearing for speech or the key skill of listening to speech with background noise. The audiogram is not a good predictor of educational outcome^[2] and only a poor predictor of maximum speech recognition score^[3]. Consequently, great care should be taken when considering the audiogram of a child as a predictor of the difficulties the child might have in a school environment.

At present there is little empirical data that specifically addresses the acoustic criteria required for the hearing impaired school population (see for example the review of the literature by Picard and Bradley^[4]). What is currently available, however, suggests that the individual hearing needs of the hearing impaired child are likely to be more demanding than those of children with normal hearing. It would be helpful for the professional specifying classroom acoustics for a particular child to have available measures of the child's aided hearing and consequent acoustic requirements in terms of, for example, acceptable levels of

Table 6.1:
Recommendations of
BATOD and ASHA for the
acoustics of classrooms

Acoustic Parameter	British Association of Teachers of the Deaf ^[5]	American Speech Language Hearing Association ^[6]
Unoccupied noise level	35 dB(A)	30 – 35 dB(A)
Reverberation time (unoccupied)	0.4 s across frequency range 125 Hz to 4 kHz	0.4 s
Signal to noise level	+20 dB across frequency range 125 Hz to 750 Hz +15 dB across frequency range 750 Hz to 4 kHz	≥ +15 dB

noise, desirable reverberation times and required signal to noise levels. However, such hearing measures are not routinely obtained.

Because it is not possible at present to provide definitive acoustic requirements for hearing impaired individuals, it is appropriate for acousticians and architects to be aware of the requirements published by specialist professional organisations. These include the British Association of Teachers of the Deaf^[5] and the American Speech Language Hearing Association^[6] (see Table 6.1). Account has been taken of these recommendations in the setting of performance criteria in Section 1.

6.3 Hearing impairment and hearing aids

Modern hearing aids are designed to make speech audible to the listener without being uncomfortably loud^[7]. They deal largely with the issue of audibility and are less able to address the issues of distortion that typically accompany a sensorineural hearing impairment.

One of the major challenges in the design of hearing aids is dealing with noise. Recent developments include the use of algorithms that attempt to enhance speech whilst reducing background noise, and better implementation of directional microphones. However, noise will continue to remain a significant obstacle to effective listening. Noise not only masks the amplified speech signal but also leaves a child tired from the effort required to listen. It is therefore essential that attention be given to creating a quiet classroom.

Sound insulation must be of a high standard, with the lowest background noise levels possible to ensure that a good signal to noise level is achieved. Typically a signal to noise level of +20 dB is considered desirable^[5]. Short reverberation times are also critical in ensuring that sound does not build up when the class are working in groups. Care must also be taken to ensure that the level of low frequency noise is kept to a minimum. For many people with impaired hearing, low frequency noise can have a devastating impact on speech recognition, masking many important speech sounds in a manner that cannot be appreciated by those with normal hearing.

6.4 The speech signal and hearing aids

Speech, as a signal, is a critical factor in classroom listening and an important speech source is the teacher. Evidence has shown that teachers' voices are not always sufficiently powerful to deliver the necessary levels of speech required to ensure the best listening opportunities^[8]. A growing body of evidence suggests that teachers are at above average risk from voice damage^[9]. Few teachers have voice training and the vocal demands of teaching are probably underestimated.

Hearing aids are usually set up to amplify a 'typical' speech signal based on various measures of the long-term average speech spectrum recorded either at the ear of the speaker or at a distance of 1 m directly in front of the average speaker, as if in conversation. If the actual speech signal is weaker than average, perhaps

because of distance, or is masked by babble or steady state background noise such as that from a classroom computer fan, then the hearing impaired listener will have increased difficulty. Listening to speech will become particularly effortful and challenging^[10].

Children are not only required to listen to the teacher but also to other children. Children typically have less powerful speaking voices^[8] and listening to their peers is frequently identified by children with hearing impairments as being difficult. One study suggests that 38% of a child's time in the classroom might be spent working in groups and 31% of the remaining time spent in mat work^[11], both situations where listening to other children is important. There are no wholly satisfactory solutions to this. Technology and careful class management have a role to play but considerable attention needs to be paid to establishing low reverberation times and maintaining low ambient noise levels in order to reduce the auditory difficulties.

To minimise the challenges to hearing, use is often made of small acoustically treated rooms attached to mainstream classrooms in the primary school. These rooms are typically large enough for a group of four to eight children to work in. To allow supervision by the class teacher they will have a large window to allow a clear view into the classroom. The room will need to have a sufficient degree of sound insulation from the classroom to allow the children to talk to each other without being disturbed or disturbing the rest of the class. The favourable acoustic conditions and short distances between children and teacher, if present, ensure that communication is as easy as possible.

6.5 Listening demands within the classroom

Much of educational activity within classrooms revolves around speech. Some experts claim that 80% of all classroom activities require listening and speaking. It is important that within any room the acoustic characteristics allow for effective spoken language communication. The UK version of the Listening Inventories

for Education^[12] identifies the following listening demands within the classroom:

- listening to the teacher when s/he is facing away from the listener
- listening when the class is engaged in activities
- listening to the teacher while s/he is moving around the classroom
- listening when other children are answering questions
- listening when other adults are talking within the same room
- listening to peers when working in groups
- listening in situations with competing background noise from multimedia equipment.

A teacher should manage teaching in such a way as to ameliorate the challenges faced by a student with hearing difficulties. However, the better the acoustic conditions, the less challenging will be the situations described above.

6.6 Strategies developed to assist children with hearing and listening difficulties

Effective classroom management by the teacher is critical in ensuring that the children can have access to all that is spoken and there are many guidelines available for teachers (see for example publications by the Royal National Institute for the Deaf^[13], the National Deaf Children's Society^[14] and DfES^[15]). Classroom management alone, however, cannot ensure that speech communication is sufficiently audible and intelligible if the classroom acoustics are not adequate, or if a child has a hearing or listening difficulty.

In order to ensure that children are able to hear the teacher and, to a lesser extent, their peers, a number of technological solutions have been developed, see Table 6.2. These solutions that work in tandem with the child's own hearing aids (if used) can be classified as either individual technology or whole class technology. In both these cases it is important to understand the underlying principles when specifying classroom acoustics.

Technology	Advantages	Disadvantages
Personal radio aids	Reduce the effect of the distance between speaker and listener Portable and convenient Particularly useful in situations where there is a poor signal to noise ratio at the position of the listener	Do not address the needs of group work directly Can require a high level of sophistication to gain maximum benefit Benefits can be lost if the child's personal hearing aid microphones are used in noisy environments
Classroom soundfield systems	Reduce the effect of the distance between the speaker and listener Inclusive technology Benefit to the teacher and the class Can ensure good signal to noise levels are maintained throughout the classroom	Do not address the needs of group work directly Poor classroom acoustics (eg high reverberation times or poor sound separation between neighbouring teaching areas) can limit the benefit of this technology
Personal soundfield amplification	Portable Addresses the issue of speaker to listener distance Can ensure favourable signal to noise levels for a particular listener or small group of listeners	Can be cumbersome to transport and manage Does not address the needs of group work directly
Auditory trainers and hard-wired systems	Provide excellent signal to noise levels Provide a high level of sound insulation Can be arranged to allow group work	Users are restricted in movement when using the device Can be heavy and uncomfortable to use Not an inclusive technology
Induction loop systems	Discreet and cheap Most hearing aids have a telecoil facility	Unpredictable acoustic response for the hearing aid user Spill over of signal into other rooms Do not deal with the needs of group work Susceptible to electromagnetic interference User normally isolated from environmental sounds

Table 6.2: Advantages and disadvantages of different technologies for aiding hearing and listening in the classroom

6.7 Individual technology

There are two main types of aid that can be used to assist children's hearing on an individual basis: radio aids that can be coupled to a child's hearing aids, and auditory trainers that are used with headphones.

6.7.1 Radio Aids

Radio aids (also known as radio hearing aids or personal FM systems) are widely used by children with hearing impairments in schools. They help overcome causes of difficulty in a classroom situation by:

- providing a good signal to noise ratio

- reducing the impact of unhelpful reverberation
- effectively maintaining a constant distance between the speaker and the listener.

All radio aids have two main components: a transmitter and a receiver. The person who is speaking (usually the teacher) wears the transmitter. A microphone picks up their voice. Typically the microphone is omnidirectional and is attached to the lapel of the speaker, however there are head worn microphones available that help ensure a consistent transmitted signal to the child.

The sounds are transmitted by an FM radio signal to the receiver, which is worn by the child. The receiver converts the signal to a sound that the child can hear.

Radio aids are usually used in conjunction with the child's hearing aids. Most children use 'direct input' (also known as 'direct connection' or 'audio input') to the hearing aids using a lead. Direct input is a facility available on many behind-the-ear (post-aural) hearing aids and a smaller number of in-the-ear hearing aids.

Alternatively, the child can use an inductive neck loop - a small wire loop that can be worn over or under clothes. The loop is connected to a radio aid receiver usually worn around the waist or attached to a belt.

Direct input is generally recommended as preferable to the use of a neck loop for children in school. This is because the level of sound that a child hears using a neck loop can be variable and there is a risk of electromagnetic interference from nearby electrical equipment.

Radio aids are also beneficial for children who have cochlear implants. The radio aid receiver is connected to the child's implant processor using a dedicated lead.

Traditionally, radio aid receivers have been worn in a chest harness or on a belt. Recent developments include miniature radio aid receivers that connect directly to a hearing aid and are worn entirely behind-the-ear. Behind-the-ear hearing aids that include built-in radio aid receivers are also being manufactured.

Most radio aids can be set up so that the child will not only hear the voice of the speaker using the transmitter, but also environmental sounds such as their own voice and the voices of other children near to them. Radio aids can do this in a number of different ways and it is often necessary to strike a balance between allowing the child to hear the voices he or she needs to listen to and the impact of hearing unwanted background noise.

For the best listening condition the hearing aid user will normally be required to mute his or her microphone on the hearing aid and listen exclusively to the

transmitted voice of the speaker. This is good for formal teaching situations but requires considerable skill on the part of the teacher to include the hearing impaired child in classroom discussion. This solution is less helpful for children engaged in group activity, where the child will need to work with a small group of peers.

Most radio aids are able to operate on a range of carrier frequencies. For example, each school class might have its own frequency so that there is no interference with a neighbouring class. In the UK, radio aid channels lie in the range 173.350 MHz to 177.150 MHz. Those channels in the range 173.350 MHz to 173.640 MHz are dedicated exclusively to use by radio aids. A licence is required to use radio aids operating on frequencies between 175.100 MHz and 177.150 MHz.

The sounds heard by a child using a radio aid will depend on the quality and correct use of their own hearing aids. The level of amplification is determined by the settings of the hearing aids, not the radio aid. Accepted procedures exist for setting up a radio aid to work with hearing aids (a process sometimes known as 'balancing').

A general principle is that if a child uses a hearing aid, then the child is also likely to find a radio aid helpful in many classroom situations.

Radio aids have often been seen as the solution to poor acoustics in the classroom. However, it must be noted that they only partially solve the problem; the solution must lie in addressing the issue from three directions:

- the class teacher and classroom management style
- technology that assists listening
- careful attention to classroom acoustics.

Current information about radio aids is available from a number of sources including the National Deaf Children's Society^[16].

6.7.2 Auditory trainers and hard-wired systems

An auditory trainer is a powerful amplifier used with high-quality headphones. As a

large, stand-alone piece of equipment, an auditory trainer can be designed without the restrictions of size that exist with typical behind-the-ear hearing aids, and a good quality high level sound output with extended low and high frequency range can be achieved.

Within the mainstream educational environment, auditory trainers are most likely to be used for short periods of individual work and speech therapy sessions. However, it is also possible to link several auditory trainers together for group work. In some schools for deaf children this equipment is permanently installed within a classroom. The teacher's voice is picked up by a microphone and the output is available at every desk. Each child wears headphones that are configured to meet their individual amplification requirements. The children may also wear microphones to enable everyone in the class to participate in discussions.

There is, however, a trend to use the inclusive technology termed 'sound field amplification' to ensure that the signal level of the speech is delivered to all parts of the classroom at an appropriate level above the background noise. This technology is of benefit for all with listening difficulties in the classroom, not just the hearing aid user, and has particular benefits for classroom management and the voice of the class teacher.

It is important to note that whole class technology is not a substitute for remedying poor classroom acoustics. However, it can be particularly valuable in maintaining good signal to noise levels and improving classroom management. Soundfield amplification systems are also used in conjunction with personal radio aids. In situations where a deaf child is part of a mainstream class, advice should be sought from members of a relevant professional group (educational audiologist, clinical audiologist or teacher of the deaf) as to the most appropriate technology.

6.8 Whole class technology

The use of a personal system is sometimes essential for a hearing aid user to be able to succeed in a particular environment.

Figure 6.1: A simple schematic drawing of a soundfield system in a typical classroom

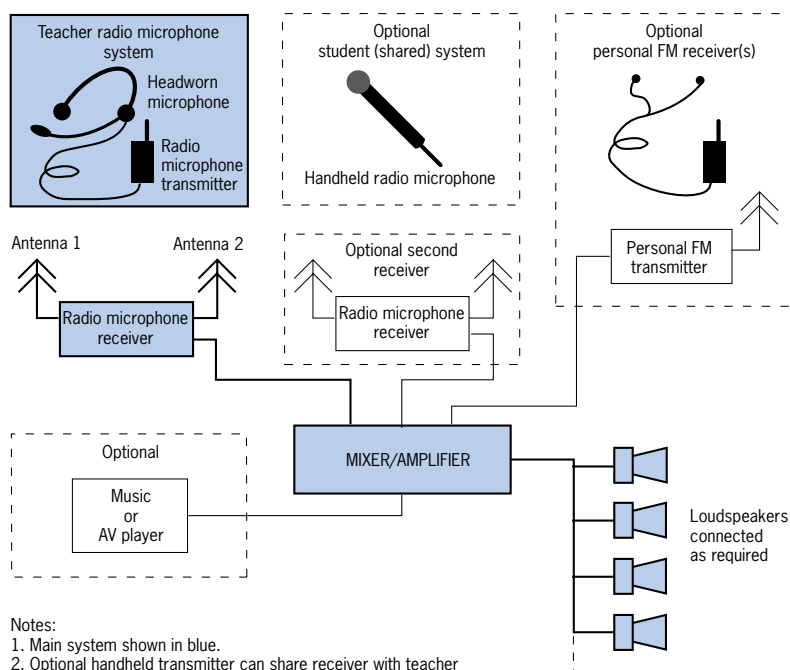

Notes:

1. Main system shown in blue.
2. Optional handheld transmitter can share receiver with teacher transmitter. Transmitters must be switched on and off as required.
3. Alternative second receiver allows simultaneous use of teacher and student transmitters.
4. Personal FM transmitter(s) for use by pupils with serious hearing impairment can be connected to output of system.
5. CD, cassette and/or video player can optionally play through the system.

6.8.1 Whole classroom soundfield systems

Soundfield systems provide distributed sound throughout a classroom. They use a wireless link between the microphone and amplifier which will operate on VHF, UHF radio or infra red frequencies. Soundfield systems have been shown to be beneficial for hearing children and children with a mild or temporary hearing loss. They will not by themselves usually provide sufficient improvement in signal-to-noise ratio for a child with a significant hearing loss, when a personal radio aid is also usually necessary.

A soundfield system is perhaps more widely known as a sound reinforcement system; the term 'soundfield' system originated from the field of Audiology and continues to be associated with classroom sound reinforcement systems. The technology has matured since it was first introduced into classrooms in the late 1970s in the USA, and has evolved to take into account new technologies and teaching management styles. Its benefits have been variously described as:

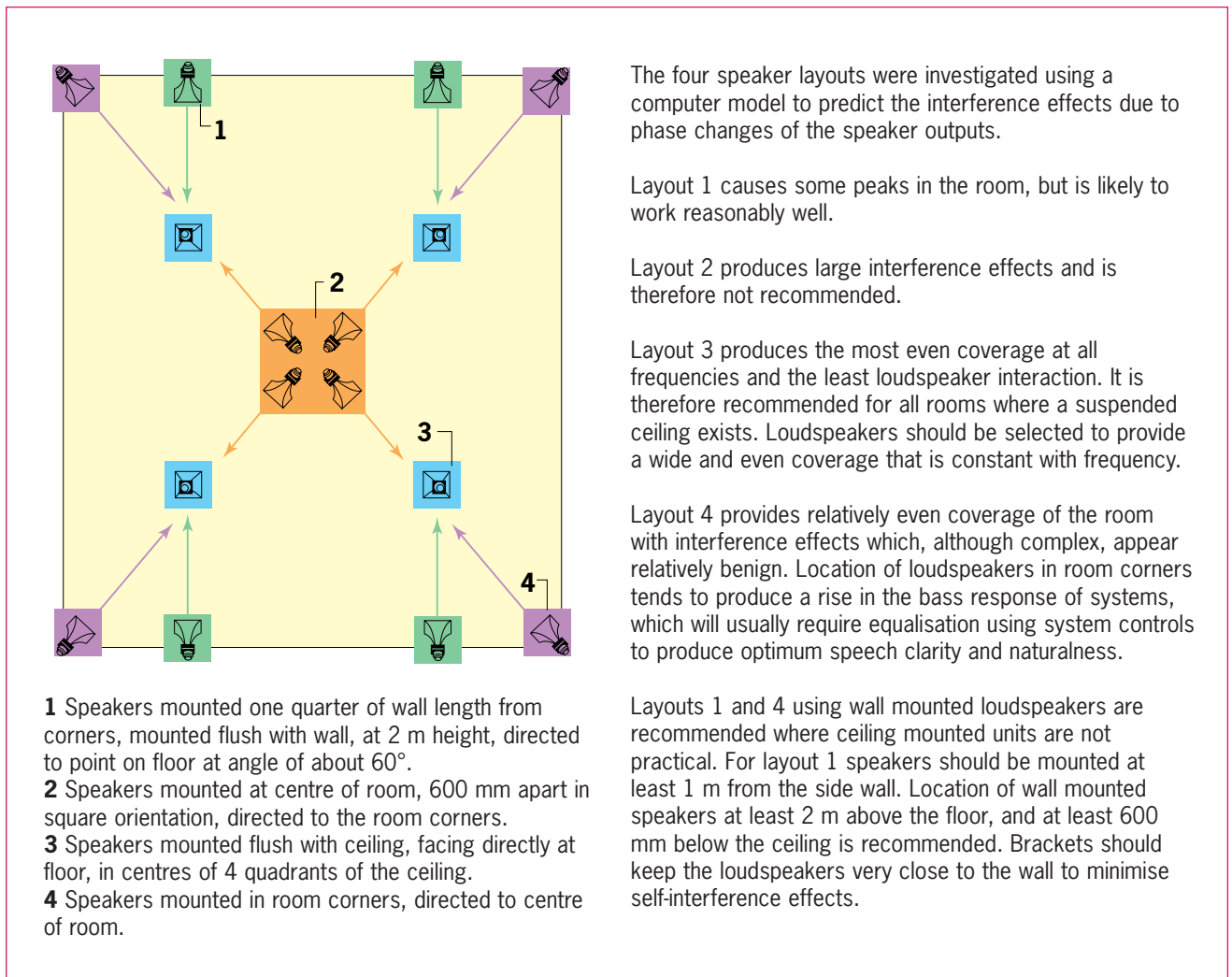

- academic improvements for all class members
- more on task behaviour
- greater attentiveness
- improved understanding of instructions
- less repetition required from the teacher
- improved measures of speech recognition
- reduced voice strain and vocal fatigue for the teacher.

6.8.2 System overview

Figure 6.1 shows a simplified block diagram of a typical soundfield system. Each element shown can be a separate unit, or some of these can be combined into an integrated unit. The current trend is for manufacturers to create more integrated products, designed especially for classroom soundfield use. Typical arrangements of loudspeakers are shown in Figure 6.2.

Table 6.3 describes the various

components of a soundfield system. A possible detailed specification is included in Appendix 9.

Where a soundfield system has not been designed specifically for the classroom it should be used for a trial period before being selected from the range available. The manufacturers and resellers should all provide installation information including commissioning of installations, operating instructions and ongoing support. Large rooms or rooms that are unusually shaped will usually need specialist advice. Teachers must receive adequate training in using the systems.

6.8.3 Personal soundfield systems

A child who cannot physically wear a conventional hearing aid, who has a unilateral hearing loss, or has Central Auditory Processing Disorder or

Figure 6.2: A plan of a classroom showing four alternative speaker layouts. The speakers are drawn horn-shaped to show the directionality of the speaker output, although many modern speakers are flat

Component	Requirements	Comments
Loudspeaker Wall mounted, ceiling mounted and flat panel speakers are used in schools.	The purpose should be to provide high quality distributed sound reinforcement throughout the whole classroom and over the whole speech frequency range. Selection of appropriate speakers should therefore address this requirement.	Often the location of loudspeakers is determined by the necessity to fit in with the current use of the classroom, when not installed as part of the original building work.
Microphone and transmitter Using Infra red, UHF or VHF carrier frequencies and high quality headworn or lapel microphones. Radio system information is available at www.radio.gov.uk	This should be a high quality system which retains both the frequency and dynamic properties of speech. It is important that teaching styles can be accommodated so a choice of microphones should be available. It is important that the transmitter can operate without interference from other systems or from public services.	In order to retain good dynamic range a compander system is typically required (see Figure 6.3). A head worn microphone can improve the consistency of the transmitted signal and help to prevent feedback that is present in systems that do not have feedback control technology. However teachers often like a choice of microphone and will use headworn, lapel or wrap around microphones depending on activity and personal preference. Battery life of at least one school day is essential for a transmitter if it is to be acceptable for school use.
Receiver Matched to the Transmitter	Will provide a complementary system to the transmitter, avoiding interference or frequency dropout.	A compander technology and diversity system is particularly suitable for classroom use, ensuring good dynamic range and avoiding frequency dropout respectively. Some teaching situations require twin channel inputs, so that a pass around radio microphone can be used. Where infra red systems are being used separate additional receivers might be necessary to avoid 'blind spots'.
Amplifier	The amplifier should be correctly matched to the loudspeaker system. It should offer a wide flat frequency response which can be adjusted if necessary. It should allow for additional inputs from multimedia within the classroom, such as the TV, computer and radio and outputs to radio systems.	Some schools might require an additional output facility for use by deaf children with personal FM systems. The amplifier is usually combined with the receiver unit.

Table 6.3: Components of a soundfield system

Attention Deficit Disorder, might use a portable soundfield system. Personal soundfield systems comprise a radio transmitter and microphone worn by the teacher and a small, portable unit for the child. The portable unit includes an FM receiver, amplifier and loudspeaker and is designed to be carried around school by the child and placed on the desk next to

them. The sound of the teacher's voice is amplified and played through the loudspeaker.

6.8.4 Infra red technology

Infra red technology has been available for many years with little market presence. However, this technology has recently undergone considerable development and

Technology	Advantages	Disadvantages
Infra red Frequency range 2.3–2.5 MHz	Physically limited to enclosed room Allows equipment to be shared between rooms Wideband transmission Can be used with personal hearing aids using a neck loop (an induction loop worn round the neck)	Occasionally needs extra IR receivers in a room
Radio VHF narrowband 173.35–177.15 MHz	Reserved frequency bands for use in schools Many frequency bands available Equipment compatible across manufacturers	Poor signal quality when compared to wideband
Radio UHF wideband 790–865 MHz	Can allow a higher quality signal than narrow band equipment Many frequency bands available, although a site licence might be required	Not available for personal FM equipment

Table 6.4: Advantages and disadvantages of infra red and radio technologies

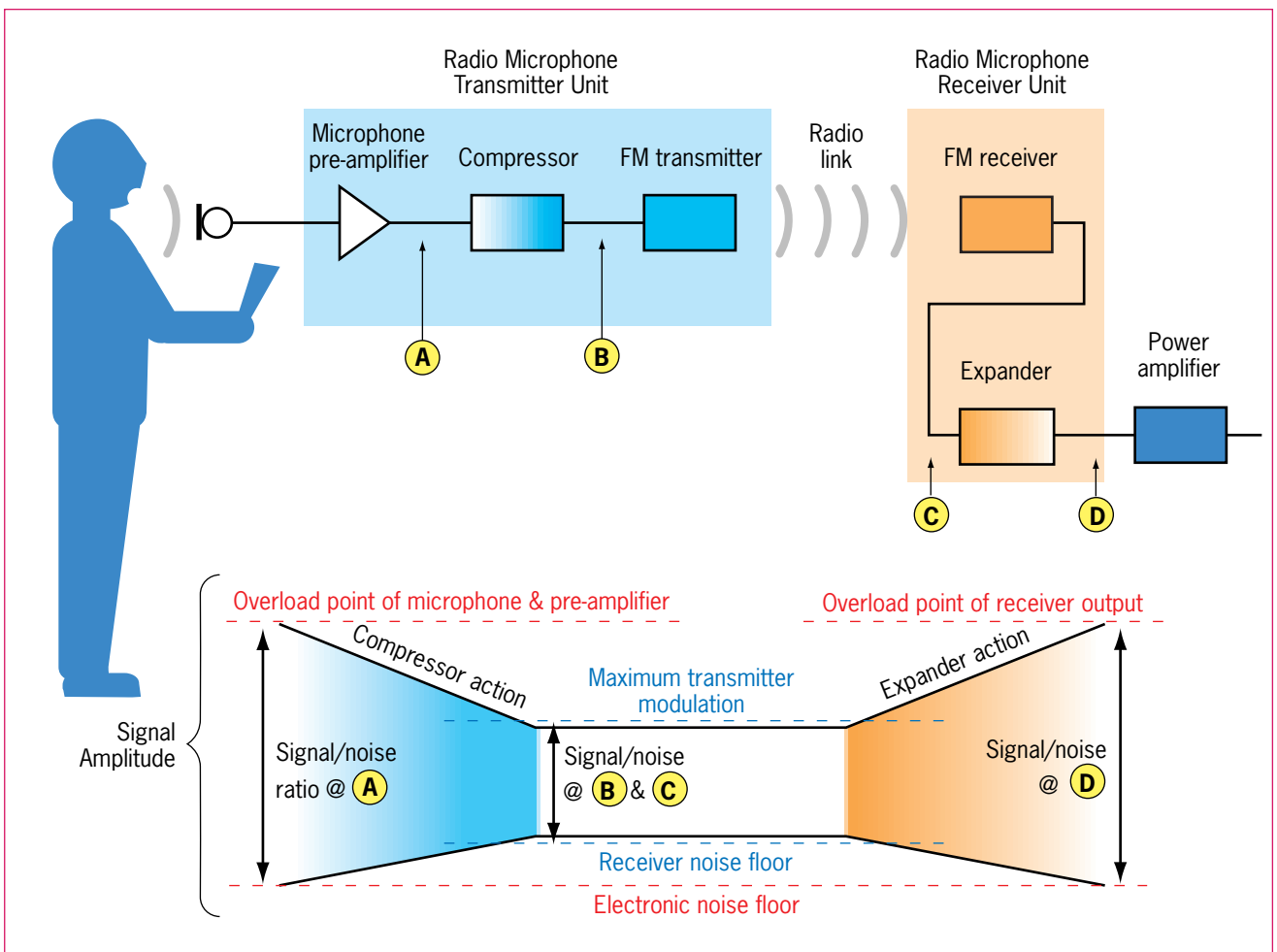

Figure 6.3: FM Radio Microphone System

EXPLANATION OF TECHNICAL TERMS

Matching Loudspeakers and Amplifier

Audio power amplifiers for sound reinforcement are made with two main types of outputs described as 'low impedance' and '100 V' or 'high impedance'. Similarly loudspeakers come in 4 or 8 ohms (low impedance) or 70 V or 100 V (high impedance).

Low impedance amplifiers and loudspeakers

If an amplifier is rated for 2, 4, 8 or 16 ohms, then it is a low impedance type. Care must be taken to ensure that the loudspeakers add up to a total load that is both within the amplifier's power rating (W or watts), and between its maximum and minimum load impedance range. Low impedance speakers, usually rated at 8 ohms for smaller types, have to be connected in a way that creates a total load within the range the amplifier is designed for. High impedance, 100 V or 70 V loudspeakers cannot be used satisfactorily. The advantage of low impedance systems is optimum audio performance, especially at low frequencies. Hi-fi loudspeakers are usually low impedance.

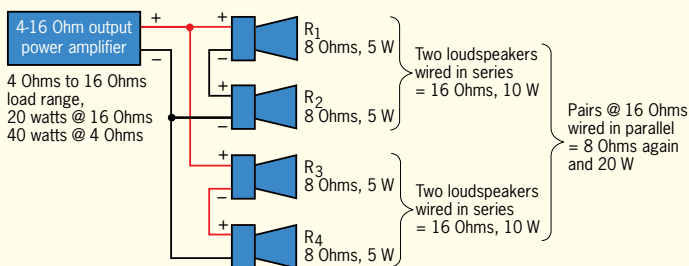
**Calculating the load impedance**

For loudspeakers wired in series – add up the individual impedances $R_{total} = R_1 + R_2 + \dots + R_N$

– add up the individual power $P_{total} = P_1 + P_2 + \dots + P_N$

For loudspeakers wired in parallel – add up reciprocals of the individual impedance

$$\frac{1}{R_{total}} = \frac{1}{R_1} + \frac{1}{R_2} + \dots + \frac{1}{R_N}$$

– add up the individual power $P_{total} = P_1 + P_2 + \dots + P_N$

In above example $R_1 + R_2 = 8 + 8 = 16$ for each series pair = R_{1+2}, R_{3+4}

Wiring the pairs in parallel gives $\frac{1}{R_1+R_2} + \frac{1}{R_3+R_4} = \frac{1}{16} + \frac{1}{16} = \frac{2}{16} = \frac{1}{8} = \frac{1}{R_{total}}$

Therefore $R_{total} = 8$

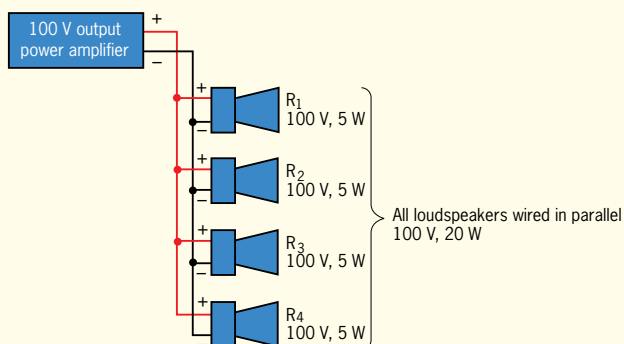
High impedance, 70 V or 100 V amplifiers and loudspeakers**Calculating the load impedance**

Impedance is taken care of automatically by the 100 V transformer in the system.

Total power is the sum of all devices connected.

is available to be used with many of the technologies identified within this section.

One of the major developments is the use of the 2.3 MHz and 2.5 MHz frequencies, allowing greater resistance to interference from fluorescent lighting and sunlight.

Table 6.4 compares the advantages and disadvantages of infra red and radio technologies.

6.8.5 Induction loop systems

Induction loop systems take advantage of the telecoil facility available with most hearing aids and cochlear implants. A telecoil is a small receiver capable of picking up audio frequency, electromagnetic signals. It is usually activated by setting a switch on the hearing aid to the "T" position. An induction loop system comprises a sound input (usually a microphone), an amplifier and a loop of cable which is run around the area in which the system is to be used. The loop generates an electromagnetic field which is picked up by the telecoil in the hearing aid. The hearing aid user will hear the sound while they are within the looped area.

Induction loop systems have many applications, from large-scale installations in theatres and cinemas to small, domestic products used to listen to the television. In the UK they are now rarely used in a classroom setting. Alternatives such as radio aids offer improved and more consistent sound quality and are less susceptible to interference. Induction loop systems can also be difficult to use in multiple applications, as the signal from one area can overspill into another.

In schools, induction loop or infra red hearing aid systems should be considered in large assembly rooms or halls. This is primarily for visitors to the school rather than for deaf pupils themselves, who would normally have their own assistive listening equipment. They should also be considered in performance spaces, meeting rooms and at reception area desks. In such situations the output from an existing PA system is often connected directly to the loop amplifier.

Pay phones in schools should have

inductive couplers (a form of induction loop).

Induction loop systems should be installed in accordance with British Standard BS7594. Their advantages and disadvantages are listed in Table 6.2.

6.8.6 Audio-visual equipment

Wherever possible, classroom equipment should be integrated with the assistive listening devices used by deaf children. For example, the audio output from audio visual equipment, televisions and cassette recorders, can be connected to radio aid or soundfield transmitters. 'Direct input' leads are available to enable the audio output of computers or language laboratory equipment to be connected directly to a child's hearing aid.

6.8.7 Other assistive devices

There is a wide range of other devices that can be used by deaf children in school, besides those that primarily assist listening. These include subtitled and signed video, speech recognition software and text telecommunication devices, eg telephones.

For further details of these devices contact the professional or voluntary organisations listed at the end of this section. Furthermore, it is recommended to seek advice to ensure that all public spaces meet the needs of deaf and hard of hearing people.

6.9 Special teaching accommodation

It is not the intention within this document to address the needs of special schools for deaf children. Specialist advice should always be sought from an educational audiologist or acoustician when designing or modifying accommodation for this particular purpose.

Many hearing impaired children attend mainstream schools with resource facilities, sometimes called 'units'. These contain specialised rooms that exceed the acoustic specifications for regular classrooms. Within these rooms, children are able to learn the language skills that might not be possible in a busy mainstream classroom. They are also

EXPLANATION OF TECHNICAL TERMS CONTINUED

High impedance, 70 V or 100 V amplifiers and loudspeakers

If an amplifier is rated for 70 V or 100 V, then it is a high impedance amplifier. It will also have a power rating. High impedance loudspeakers, rated at 70 V or 100 V must be used. All loudspeakers should be either 70 V or 100 V. In this case the loudspeakers are simply wired in parallel and their individual power requirements are added up. Thus four 100 V loudspeakers rated at 5 W would be wired in parallel and will provide a 20 W load to the amplifier. External transformers can be added to low impedance loudspeakers to convert them for high impedance use. The advantage of this method is simple wiring. PA, paging and SFS loudspeakers are usually 100 V types in the UK.

Radio Microphone System

Compressor system (See Figure 6.3)

FM (frequency modulated) radio links provide a signal to noise ratio that is determined by the modulation bandwidth of the transmitter. Wider bandwidths allow fewer channels in a band of available frequencies, so regulations limit the bandwidth to two system types described as wideband FM and narrowband FM. Even wideband provides a limited signal to noise ratio of about 65 dB from real products. This is adequate if everything is perfectly adjusted so that a user's voice hits just below the maximum permitted signal level. However real users vary their voices, different users share systems AND they are often not correctly adjusted anyway. A compressor system combines a compressor on the transmitter of the system, and an expander on the receiver. The two are matched in their action so that the result on the receiver output is very close to the original input signal. What happens is that a larger signal range of say 90 dB is compressed by 50% to fit into 45 dB. This allows for an improved safety margin in the transmitter so that it does not overload, and allows a wide working range that will tolerate user variations. At the receiver the 45 dB range is expanded back to 90 dB. This pushes the system noise down and the signal up. The result is a signal free from distortion due to overload and with a much reduced background noise when a soft talker is turned up at the receiver.

Diversity receiver

A FM radio microphone system emits a signal that has a fairly long wavelength. The waves can reflect from room surfaces and arrive at the receiver antenna in a way that causes the waves to cancel. The result is a 'dropout' which will be heard as a disappearance of the audio from the system. If the dropout is maintained, for example if the user is standing still in a location that produces a cancellation, the receiver can even hunt and locate an alternative signal to lock onto - though this is uncommon. A diversity receiver provides two independent radio and audio paths, including two spaced antennae. The spacing minimises the risk that both antennae will receive a cancelled signal simultaneously. The unit will automatically and instantaneously select the stronger of the two signals to the audio output. While audio dropouts may be only slightly disturbing to a person with normal hearing, the hearing impaired child, especially one reliant upon a personal FM receiver, will get nothing and could therefore frequently lose the whole meaning or context of a piece of verbal information. Therefore, where possible, diversity receivers should be used.

places where children can interact within a favourable acoustic environment.

It is not uncommon for these rooms to be used for 'reverse integration', where a small group of children from the mainstream work with the hearing impaired children. Occasionally this provision may be directly attached to a mainstream class in the form of a 'quiet room' leading from the classroom. In other situations the accommodation might be a separate room or even building. Teachers and support professionals might also use the areas for a range of activities involved in the

audiological management of the hearing impaired child. Case Study 7.6 describes a junior school with a hearing impaired unit, now renamed as the RPD (Resource Provision for the Deaf). The characteristics of rooms in an RPD are:

- excellent sound insulation
- very short reverberation times
- very low ambient noise levels
- flexible space for individual and small group work
- good lighting
- storage facilities for audiological equipment.

Organisations

British Association of Audiological Scientists	http://www.baas.org.uk
British Association of Educational Audiologists	http://www.edaud.org.uk
British Association of Teachers of the Deaf	http://www.batod.org.uk
British Society of Audiology	http://www.b-s-a.demon.co.uk
National Deaf Children's Society	http://www.ndcs.org.uk
Royal National Institute of the Deaf	http://www.rnid.org.uk

Glossary

Term	Explanation
Natural-oral approach	An approach to the education of children with hearing impairments that seeks to promote the acquisition of spoken language using residual hearing.
Residual hearing	A term used to describe the hearing abilities that remain in the case of a hearing impairment.
Hearing aid	A battery powered device worn by an individual, either behind the ear or in the ear. A hearing aid will be selected and programmed to provide the maximum audibility of the speech signal consistent with an individual's residual hearing.
Cochlear implant	A special kind of hearing aid where the inner ear is directly stimulated electrically via an implanted electrode.
Central auditory processing difficulty	A broad term used to describe listening difficulties, which are not due to the outer, middle or inner ear.
Radio aid	An assistive listening device, designed to provide an FM radio link between a transmitter (usually on the speaker) and the listener (coupled directly to the hearing aids).

6.10 Beyond the classroom

As far as possible children with hearing impairments should be included in all school activities. Improving listening conditions through better acoustics is a very important part of this, but not the only relevant factor. There are many others such as teaching style and context, staff training, deaf awareness issues, and a whole school approach to special educational needs.

Classrooms are not the only places where hearing impaired children interact. It is often overlooked in school design, but critical learning and interaction takes place outside the classroom, and if hearing impaired children are to be fully included, attention should be given to all areas of the school where the children might be expected to interact with others. These areas include rooms where aspects of the curriculum are delivered: libraries, assembly areas, sports halls, music rooms, ICT suites and gymnasias. In these areas the need for good speech communication is essential although constrained by the activities taking place.

Inclusion in most music activities requires good acoustic conditions, good planning and structuring of lessons, and the appropriate use of assistive listening devices.

Perhaps the most difficult areas for inclusion are large spaces such as assembly halls and sports halls. These areas require careful design and forethought.

In other areas, not used for delivering the curriculum, children still need to be able to interact verbally. These include the corridors, cloakrooms, medical rooms, school office, dining room, play areas and toilets. In these communal places important social interaction often takes place and if inclusion is to be effective, these areas need to be designed with the acoustic needs of the hearing impaired child and the child with listening difficulties in mind.

References

- [1] M Eatough, Deaf Children and Teachers of the Deaf England, BATOD magazine, 2000.
- [2] S Powers, S Gregory and E D Thoutenhoofd, The Educational Achievements of Deaf Children, DfES, 1998.
- [3] J M Bamford, *et al.*, Pure tone audiograms from hearing-impaired children. II. Predicting speech-hearing from the audiogram. *Br J Audiol*, 15(1), 3-10, 1981.
- [4] M Picard and J S Bradley. Revisiting speech interference in classrooms. *Audiology*, 40(5), 221-44, 2001.
- [5] BATOD, Classroom Acoustics - Recommended standards. 2001.
- [6] ASHA, Position Statement and guidelines for acoustics in educational settings. *ASHA*, 37(14), 15-19, 1995.
- [7] S Gatehouse and K Robinson. Speech tests as a measure of auditory processing, in *Speech Audiometry*, Second Edition, M Martin, (Editor) Whurr: London, 1997.
- [8] A Markides, Speech levels and speech-to-noise ratios. *Br J Audiol*, 20(2), 115-20, 1986.
- [9] J A Matisse, J M Oates and K M Greenwood. Vocal problems among teachers: a review of prevalence, causes, prevention, and treatment. *J Voice*, 12(4), 489-99, 1998.
- [10] T Finitzo-Hieber and T W Tillman. Room acoustics effects on monosyllabic word discrimination ability for normal and hearing-impaired children. *J Speech Hear Res*, 21(3), 440-58, 1978.
- [11] O Wilson *et al.*, Classroom Acoustics, Oticon Foundation in New Zealand: Wellington, 2002.
- [12] D Canning. Listening Inventories For Education U.K., in LIFE UK, City University, London, 1999.
- [13] RNID, Guidelines for mainstream teachers with deaf pupils in their class. Education guidelines project, RNID, 2001.
- [14] National Deaf Children's Society, Deaf Friendly Schools – a Guide for Teachers and Governors, NDCS, 2001.
- [15] DfES, Special Education Needs Code of Practice, DfES/581/2001.
- [16] B Homer, R Vaughan and K Higgins, Radio Aids, NDCS, 2001.
- [17] National Deaf Children's Society, Quality Standards in Education - England, NDCS, 1999.

